

DESIGN / CONSTRUCTION

Overwatch Body	304L SS
External Hardware	304L SS
Gaskets	Buna-N
Motor Body	Cast Iron
Shaft Seal	Single Mechanical Seal
Impeller	200mm DIPCUT® Impeller Standard (Vortex or Channel optional)
Maximum Solid Size ϕ	4.3" (110 mm)

MOTOR SPECIFICATIONS

Motor Design	4-Pole, 3-Phase Squirrel-Cage Motor 50Hz/60Hz
Motor Type	TEFC, IP67
Insulation Class	Class F
Motor Protection	Protected by VFD
Service Factor	1.15
Maximum Ambient Temp.	104°F (40°C)
Voltage Tolerance	±10%

MOTOR DATA

Rated Power	230V FLA	460V FLA	575V FLA	Weight *
5.5kW / 7.4HP	21.6	10.8	8.6	487lb (221kg)
7.5kW / 10.1HP	29	14.5	11.6	528lb (240kg)
11kW / 14.8HP	44	22	17.6	686lb (311kg)
15kW / 20.1HP	58	29	23.2	820lb (372kg)

DIMENSIONS (largest motor)

Inlet	8" ANSI 150#
Outlet	6" ANSI 150#
H1	18" (457mm)
H2	17.1" (434mm)
L	40.6" (1031mm)
P	37" (943mm)

* Total weight of unit

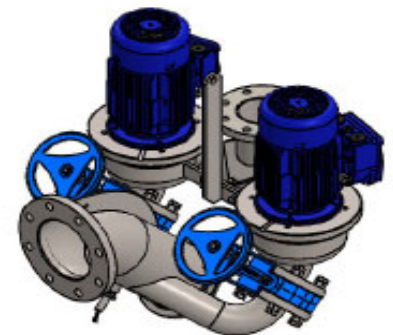
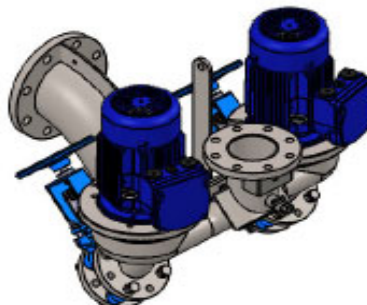
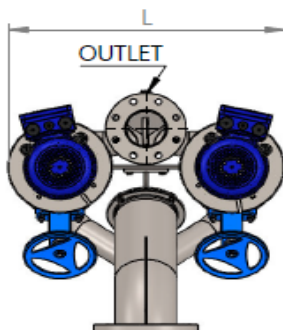
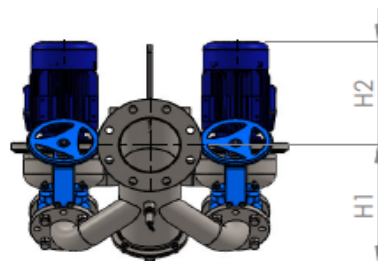
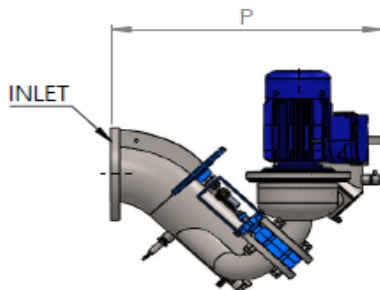

DESIGN / CONSTRUCTION

Overwatch Body	304L SS
External Hardware	304L SS
Gaskets	Buna-N
Motor Body	Cast Iron
Shaft Seal	Single Mechanical Seal
Impeller	200mm DIPCUT® Impeller Standard (Vortex or Channel optional)
Maximum Solid Size \varnothing	4.3" (110 mm)

MOTOR SPECIFICATIONS

Motor Design	6-Pole, 3-Phase Squirrel-Cage Motor 50Hz/60Hz
Motor Type	TEFC, IP67
Insulation Class	Class F
Motor Protection	Protected by VFD
Service Factor	1.15
Maximum Ambient Temp.	104°F (40°C)
Voltage Tolerance	±10%

MOTOR DATA

Rated Power	230V FLA	460V FLA	575V FLA	Weight *
5.5kW / 7.4HP	23.6	11.8	9.4	514lb (233kg)

DIMENSIONS (largest motor)

Inlet	8" ANSI 150#
Outlet	6" ANSI 150#
H1	18" (457mm)
H2	17.1" (434mm)
L	40.6" (1031mm)
P	37" (943mm)

* Total weight of unit

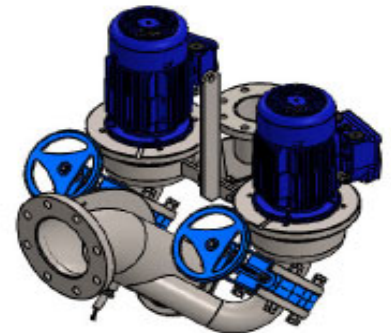
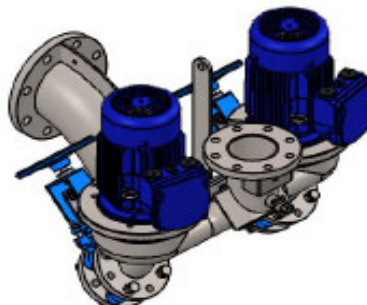
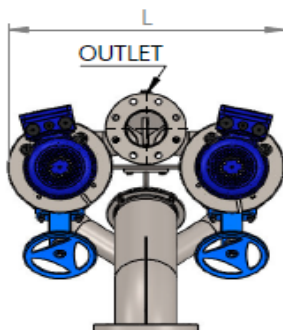
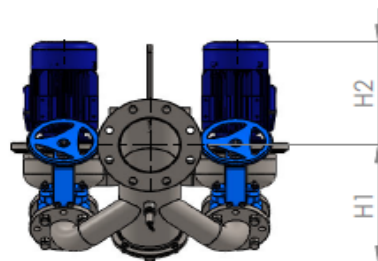
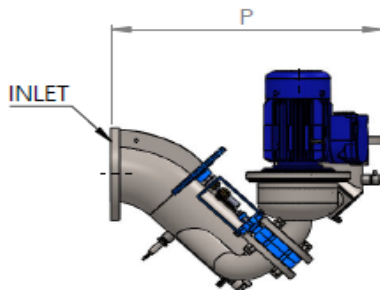

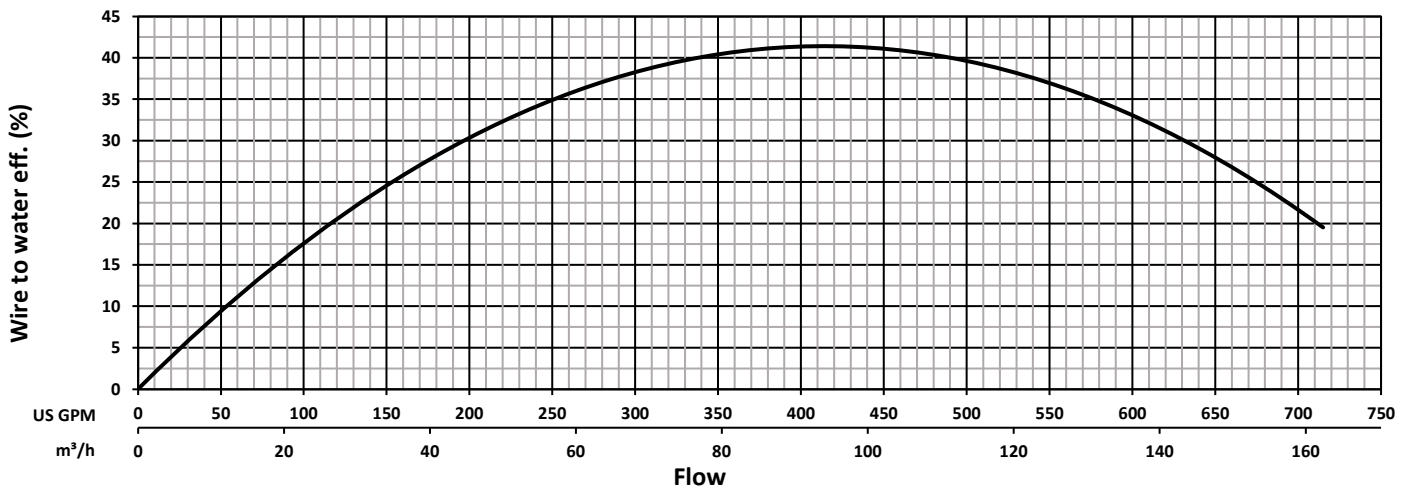
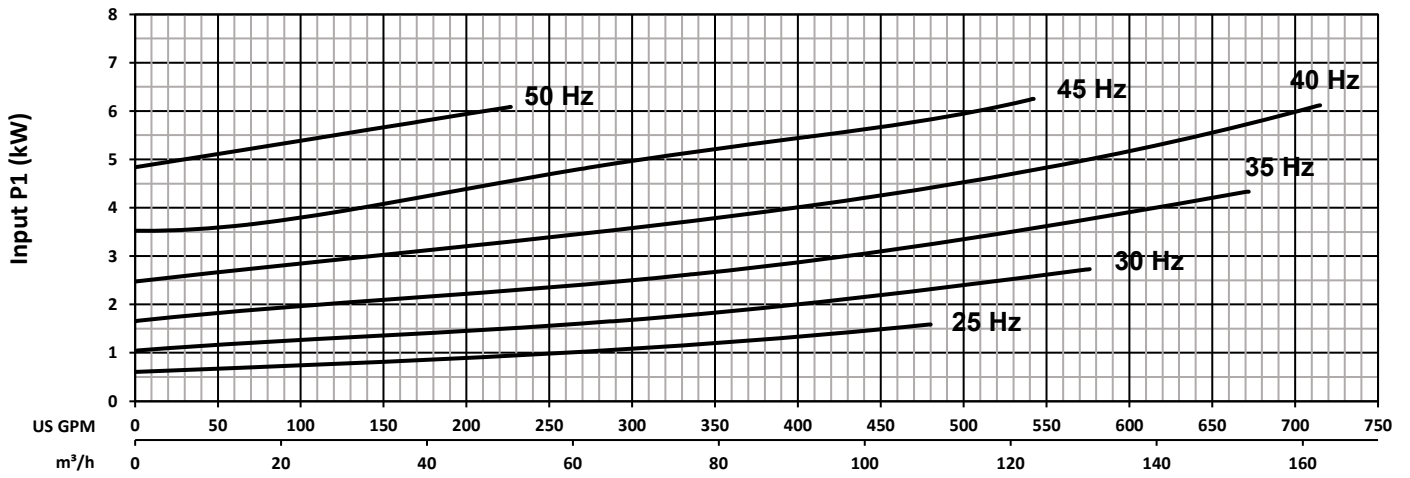
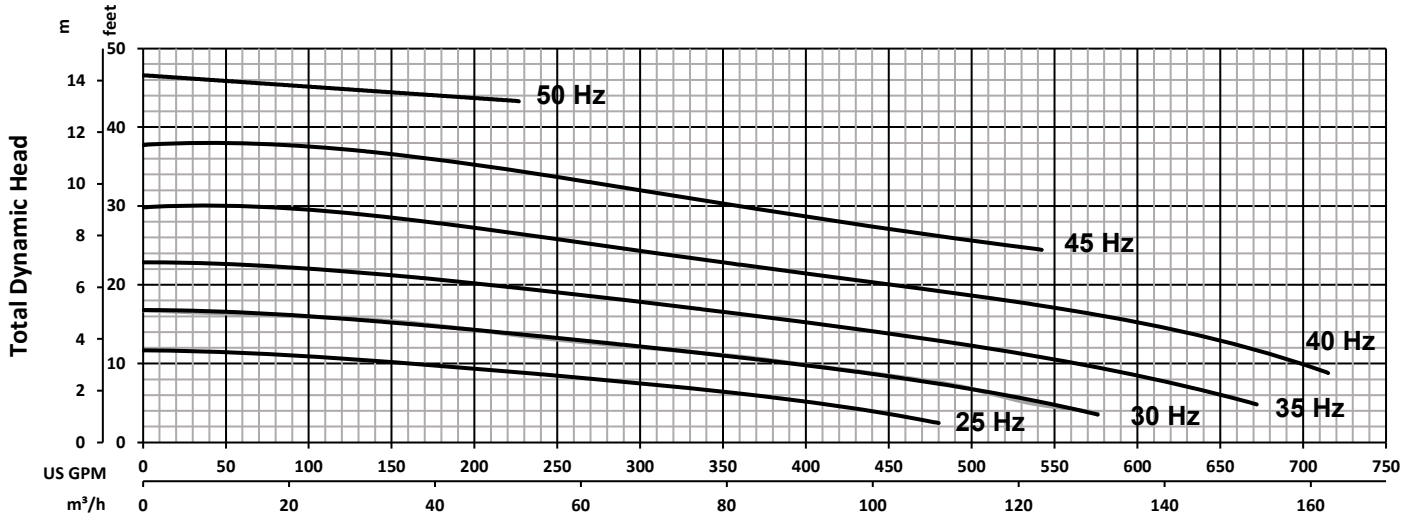

PERFORMANCE CURVE OW101-4VV 5.5kW

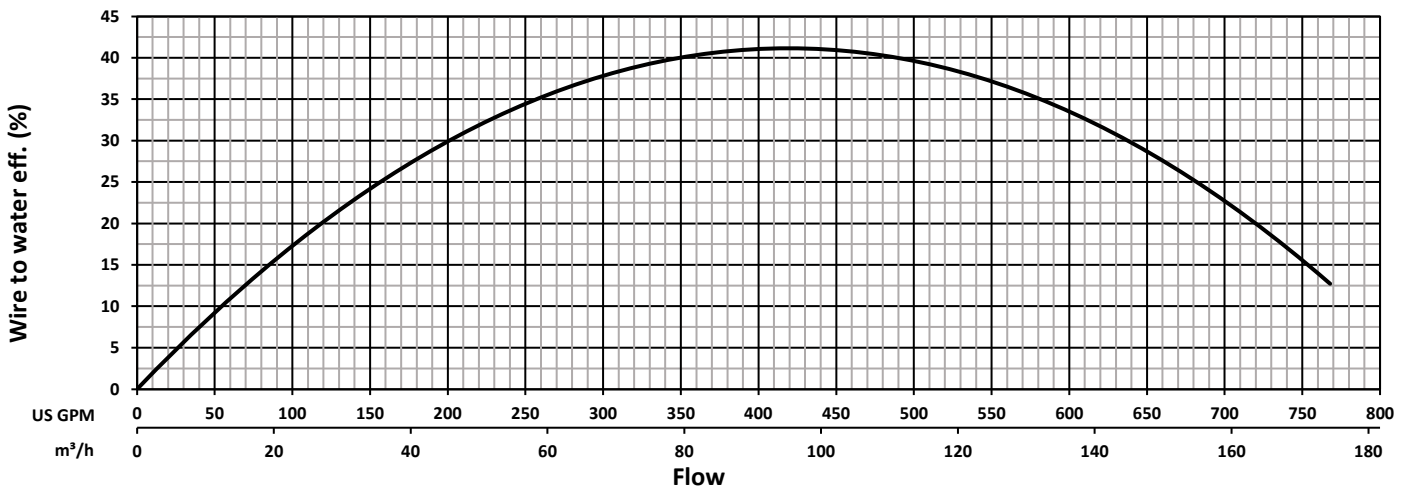
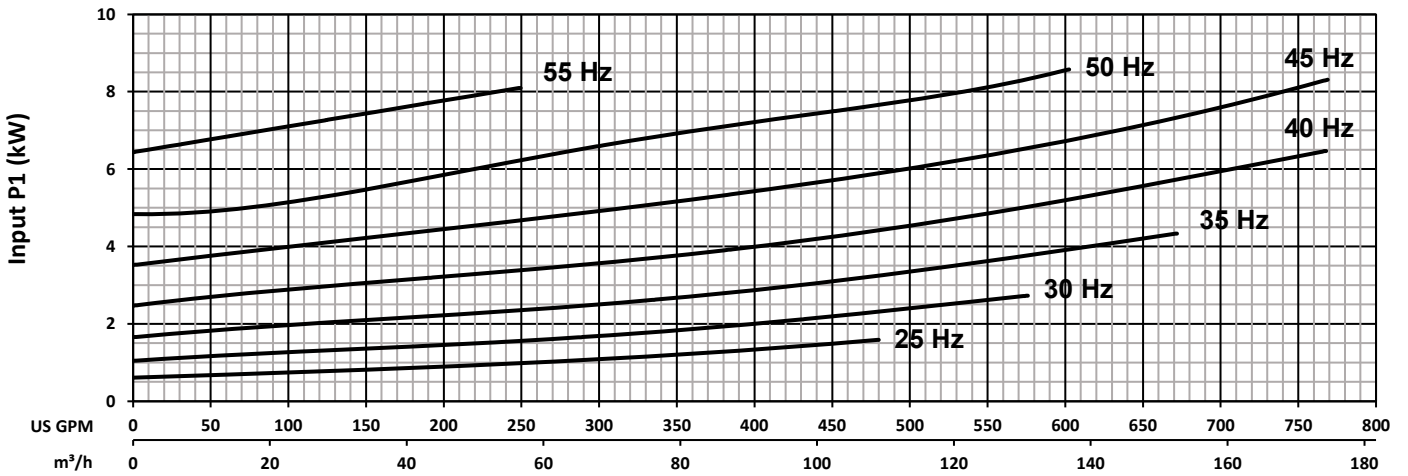
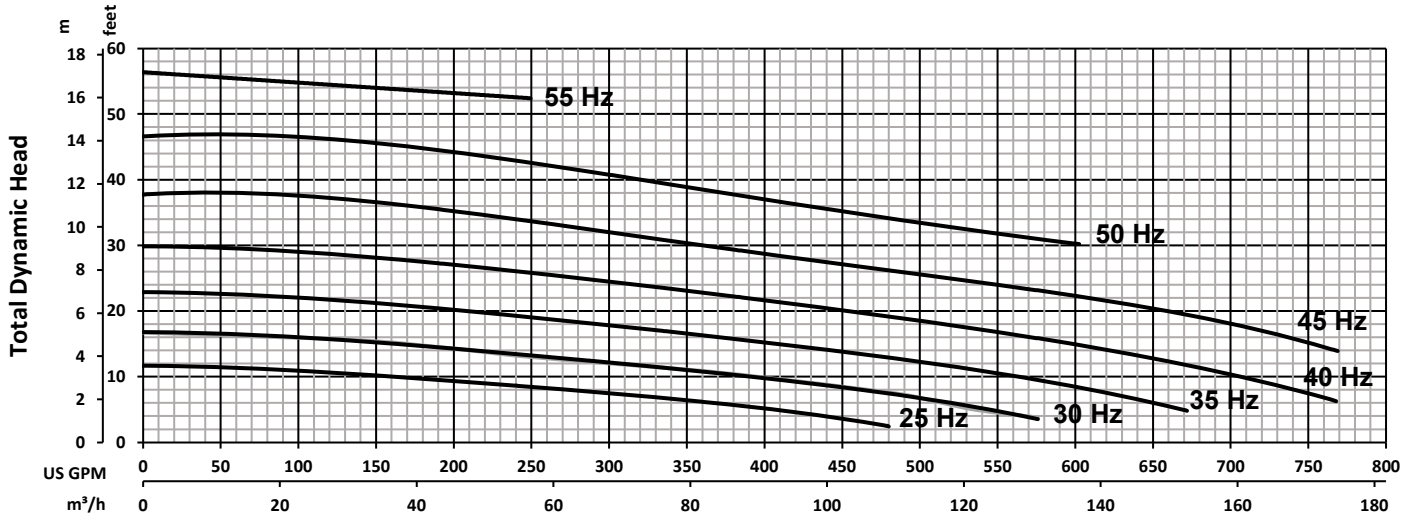

 INDUSTRIAL FLOW SOLUTIONS	PERFORMANCE CURVE			DS-A50-019
	Tested with clean water Test Standard : HI 11.6 Gr 3B		Model	OW101-4VV 5.5kW
			Motor	5.5kW / 7.4HP
			Poles	4
		Impeller Ø	200mm	Rev -- Date 2/27/2020 Specifications subject to change without notice

PERFORMANCE CURVE OW101-4VV 7.5kW



 INDUSTRIAL FLOW SOLUTIONS	PERFORMANCE CURVE			DS-A50-020
	Tested with clean water Test Standard : HI 11.6 Gr 3B		Model	OW101-4VV 7.5kW
			Motor	7.5kW / 10.1HP
	Tested with clean water Test Standard : HI 11.6 Gr 3B		Impeller Ø	200mm

PERFORMANCE CURVE OW101-4VV 11.0kW

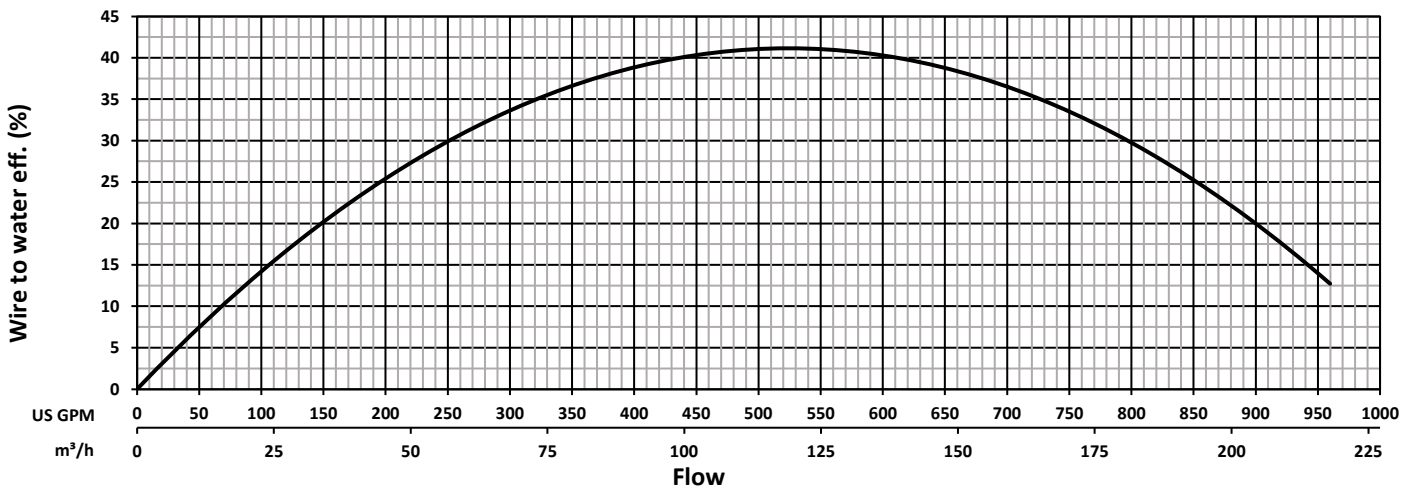
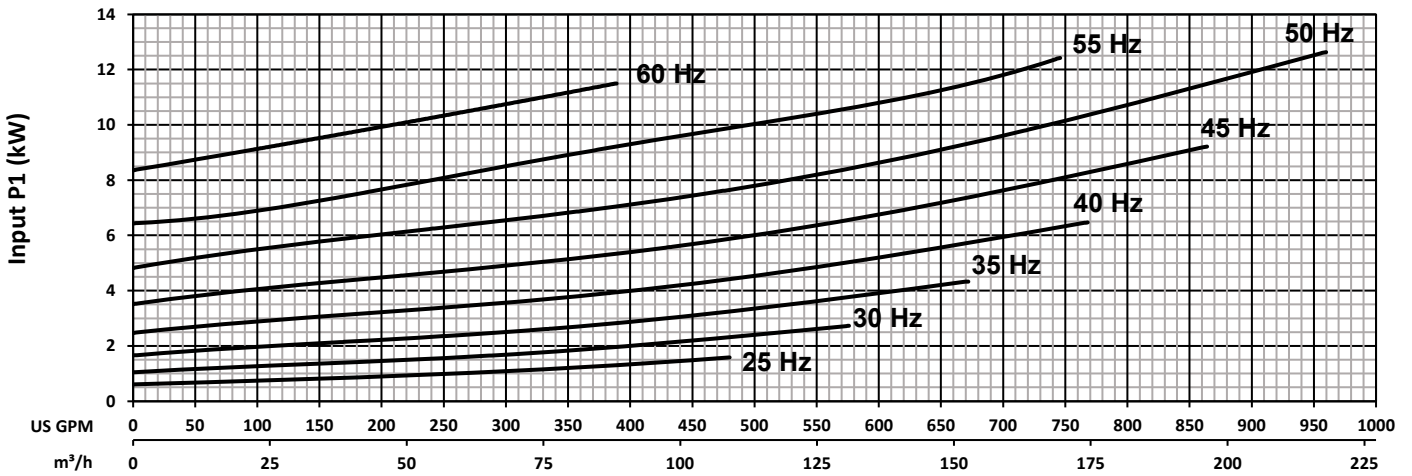
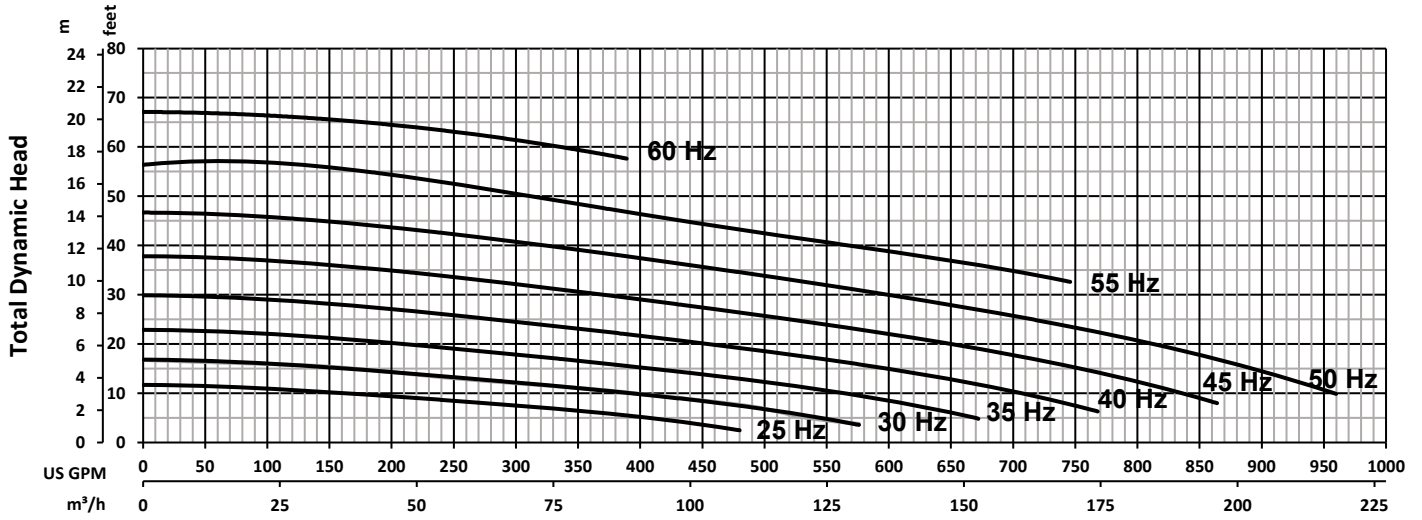

 INDUSTRIAL FLOW SOLUTIONS	PERFORMANCE CURVE			DS-A50-021	
	Tested with clean water Test Standard : HI 11.6 Gr 3B	Model	OW101-4VV 11.0kW		Rev --
		Motor	11kW / 14.8HP	Poles 4	Date 2/27/2020
		Impeller Ø	200mm	Specifications subject to change without notice	

PERFORMANCE CURVE OW101-4VV 15.0kW

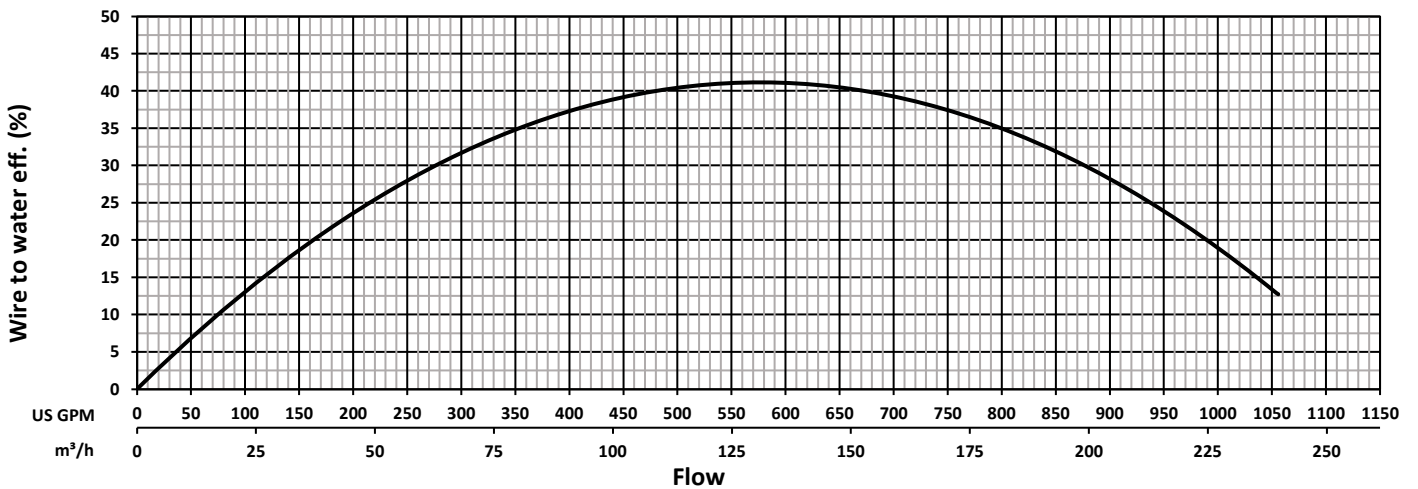
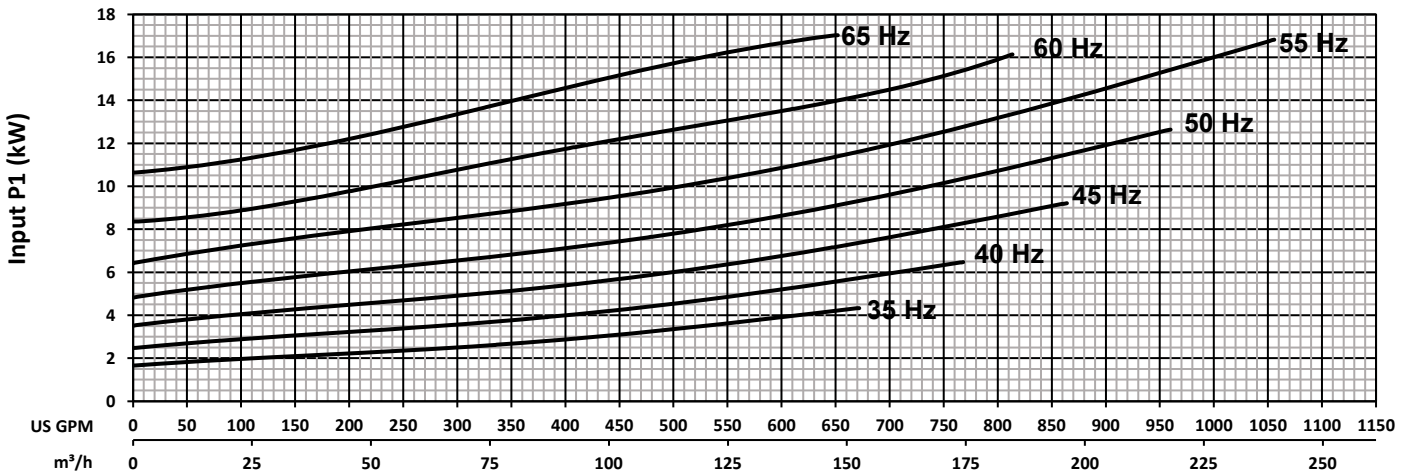
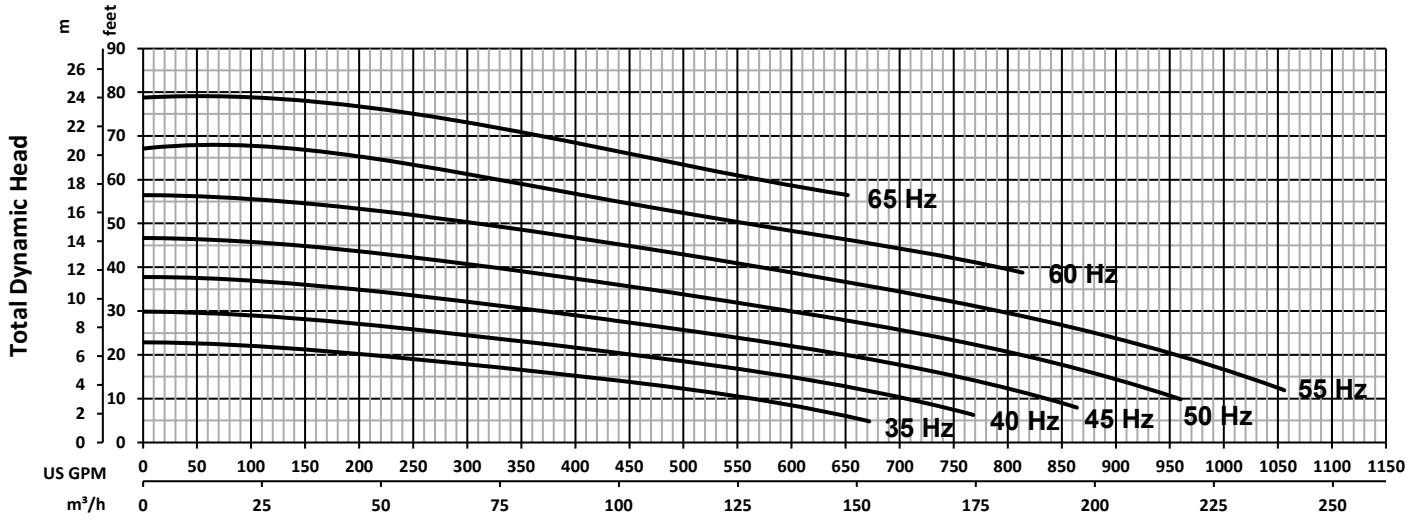

 INDUSTRIAL FLOW SOLUTIONS	PERFORMANCE CURVE			DS-A50-022	
	Tested with clean water Test Standard : HI 11.6 Gr 3B	Model	OW101-4VV 15.0kW		Rev --
		Motor	15kW / 20.1HP	Poles 4	Date 2/27/2020
		Impeller Ø	200mm	<small>Specifications subject to change without notice</small>	

PERFORMANCE CURVE OW101-6VV 4.0kW

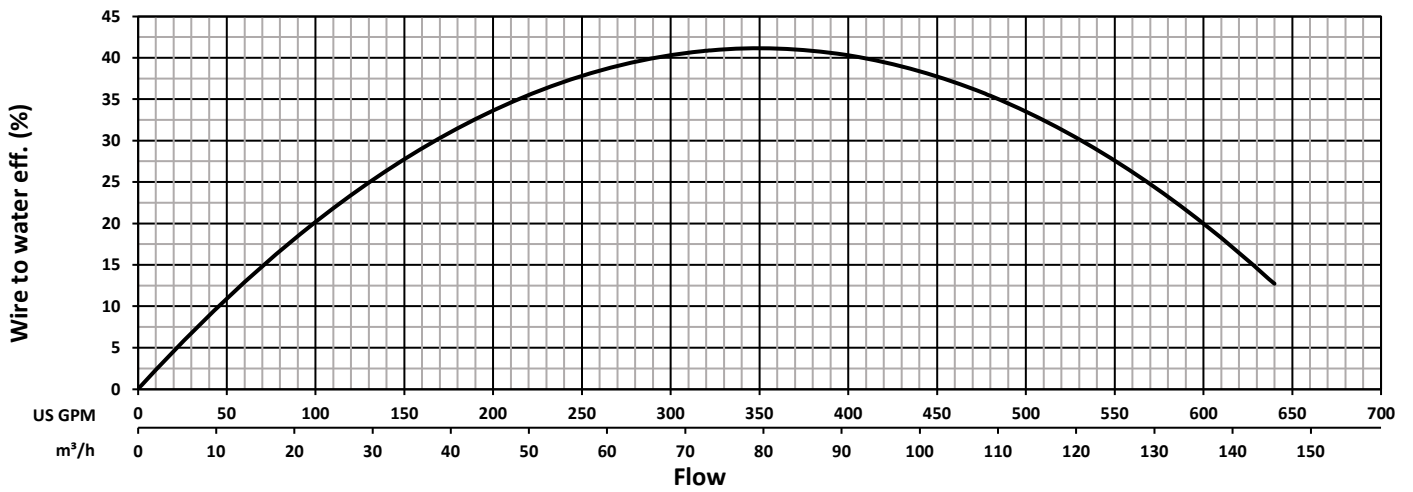
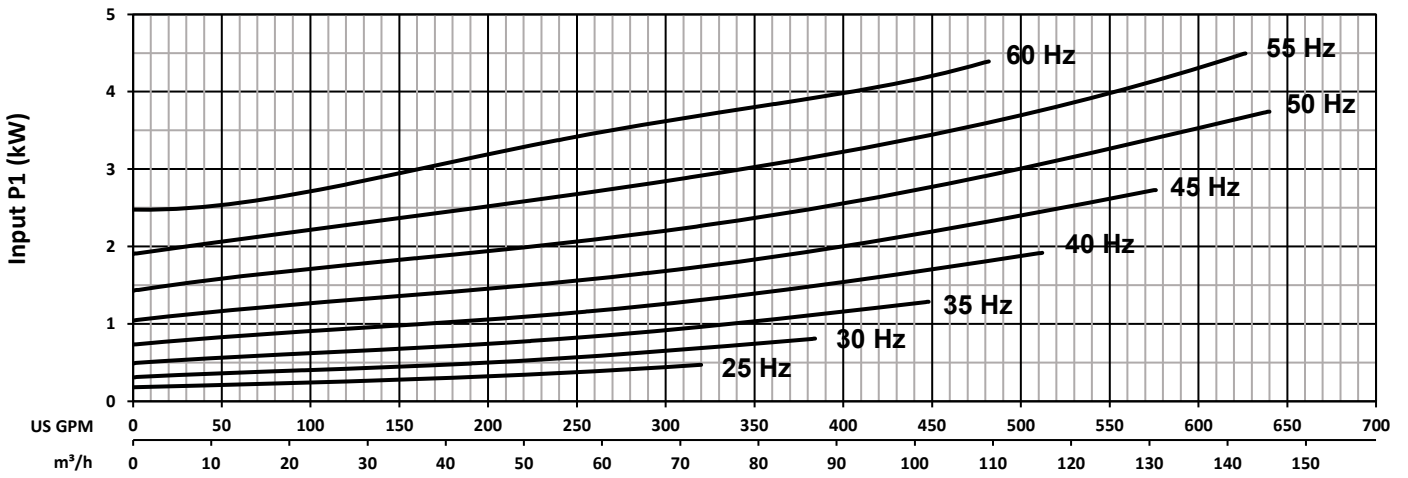
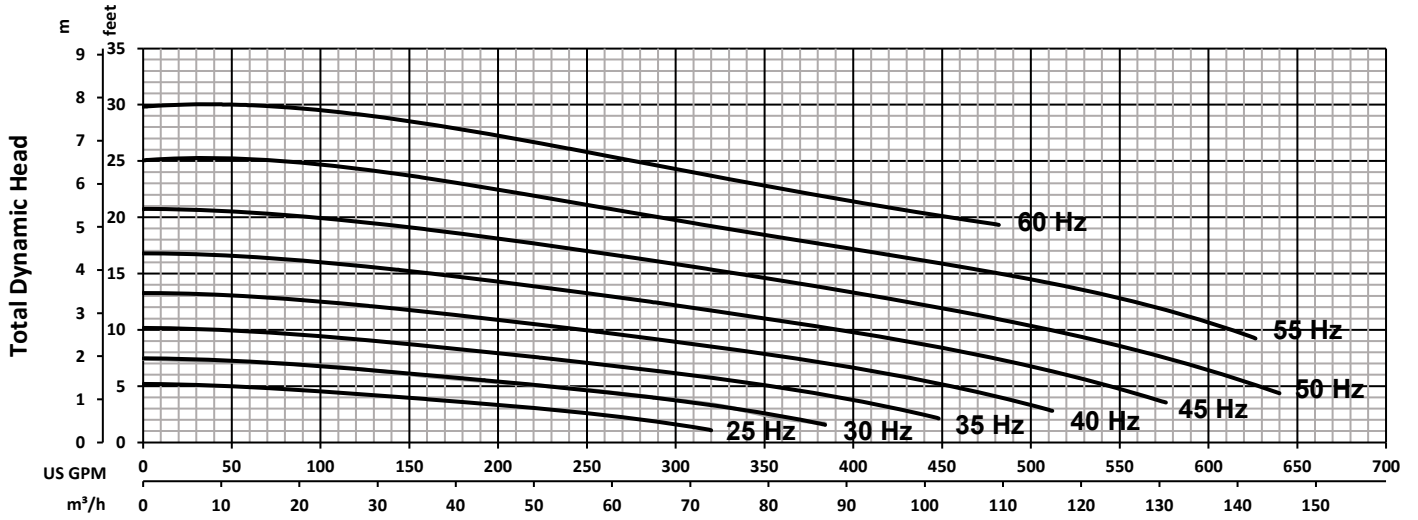

 INDUSTRIAL FLOW SOLUTIONS	PERFORMANCE CURVE			DS-A50-023	
	Tested with clean water Test Standard : HI 11.6 Gr 3B		Model	OW101-6VV 4.0kW	Rev --
			Motor	4kW / 5.4HP	Poles 6
			Impeller Ø	200mm	Date 2/27/2020
Specifications subject to change without notice					