

DESIGN / CONSTRUCTION

Body	304L SS
External Hardware	304L SS
Gaskets	Buna-N
Motor Body	Cast Iron
Shaft Seal	Single Mechanical Seal
Impeller	165mm DIPCUT® Impeller Standard (Vortex or Channel optional)
Maximum Solid Size ϕ	3.0" (80mm)

MOTOR SPECIFICATIONS

Motor Design	2-Pole, 3-Phase Squirrel-Cage Motor 50Hz/60Hz
Motor Type	TEFC, IP67
Insulation Class	Class F
Motor Protection	Protected by VFD
Service Factor	1.15
Maximum Ambient Temp.	104°F (40°C)
Voltage Tolerance	±10%

MOTOR DATA

Rated Power	230V FLA	460V FLA	575V FLA	Weight *
11kW / 14.8HP	41.2	20.6	16.5	970lb (441kg)
15kW / 20.1HP	--	26.5	21.2	1049lb (477kg)
18.5kW / 24.5HP	--	32.2	25.8	1102lb (501kg)

DIMENSIONS (largest motor)

Inlet	6" ANSI 150#
Outlet	4" ANSI 150#
H1	14.95" (380mm)
H2 **	27" (685mm)
L	34.5" (876mm)
P	32.5" (825mm)

* Total weight of unit

** Max

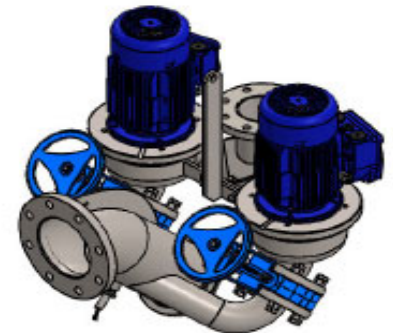
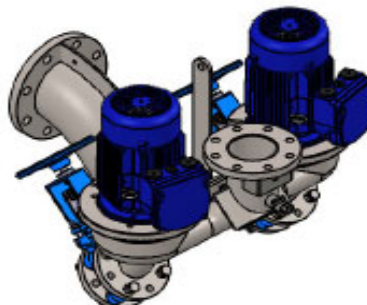
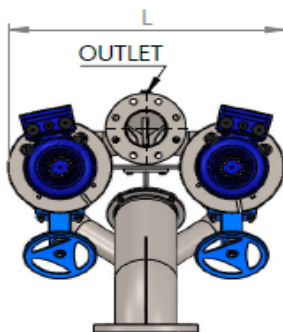
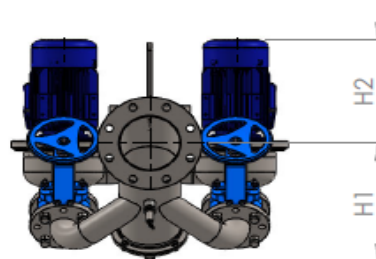
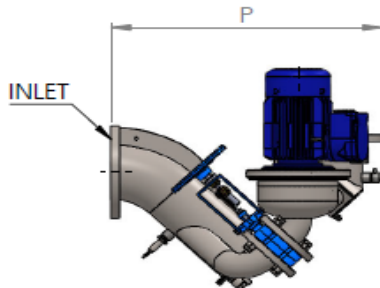

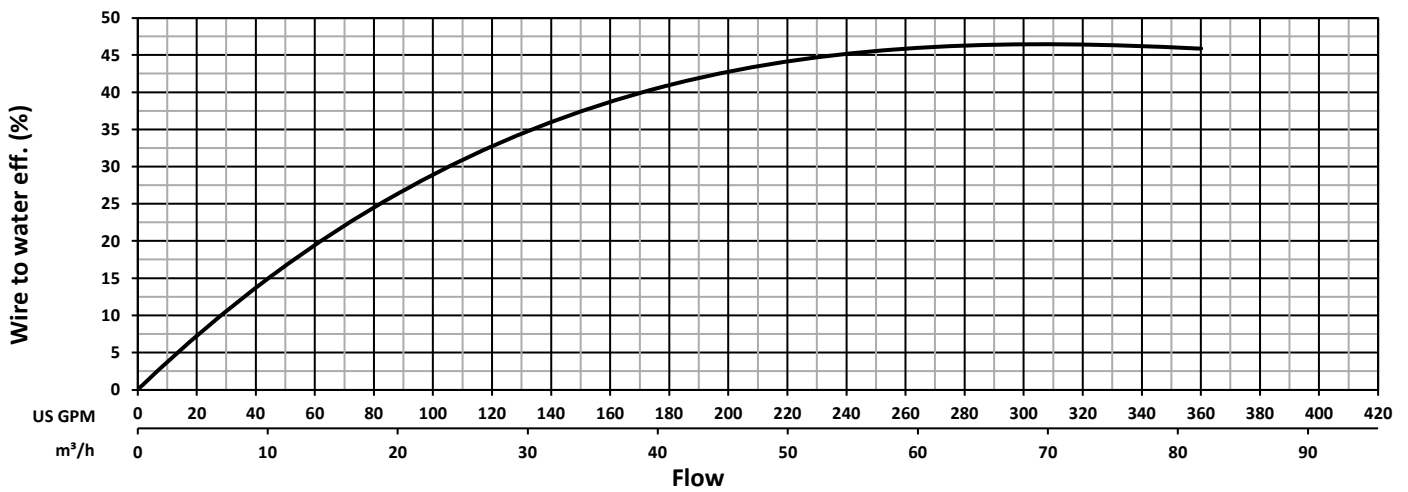
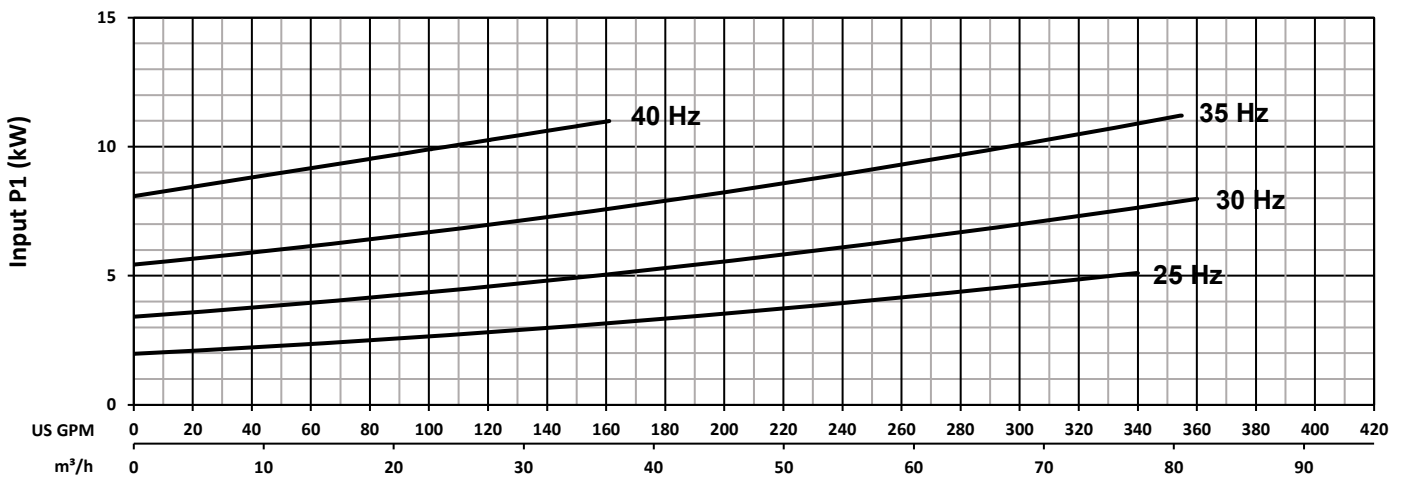
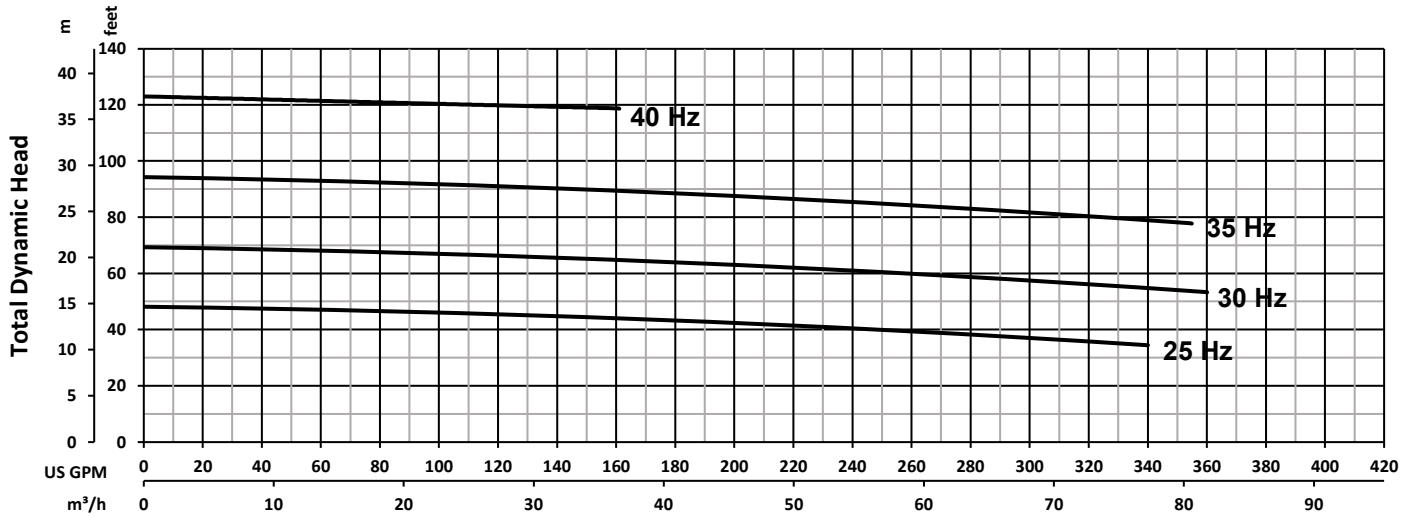

PERFORMANCE CURVE OW61R-2VV 11.0kW

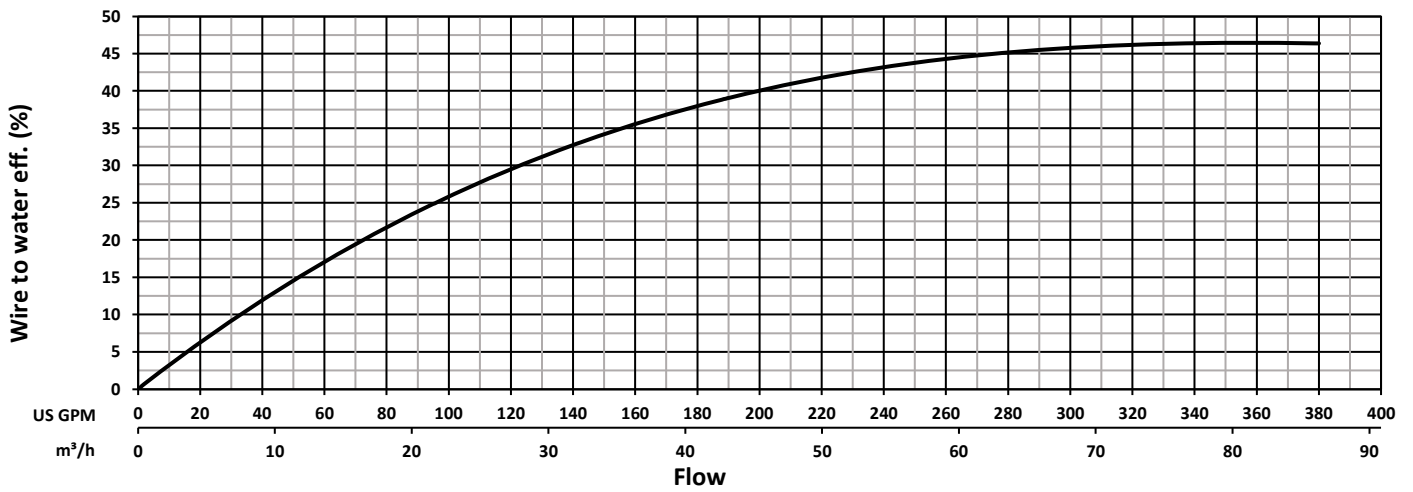
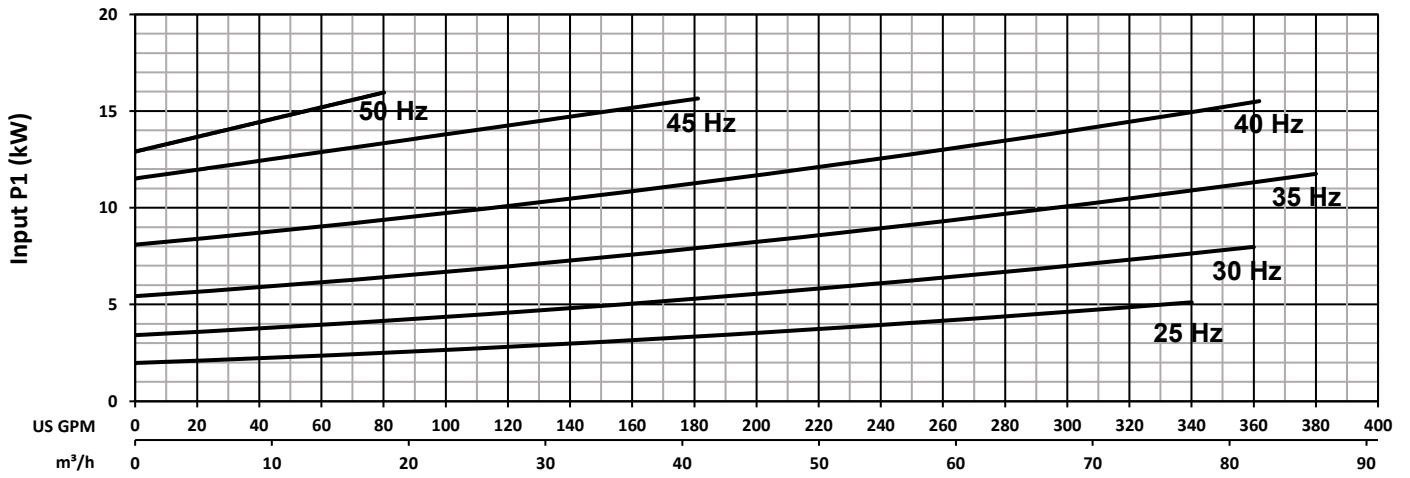
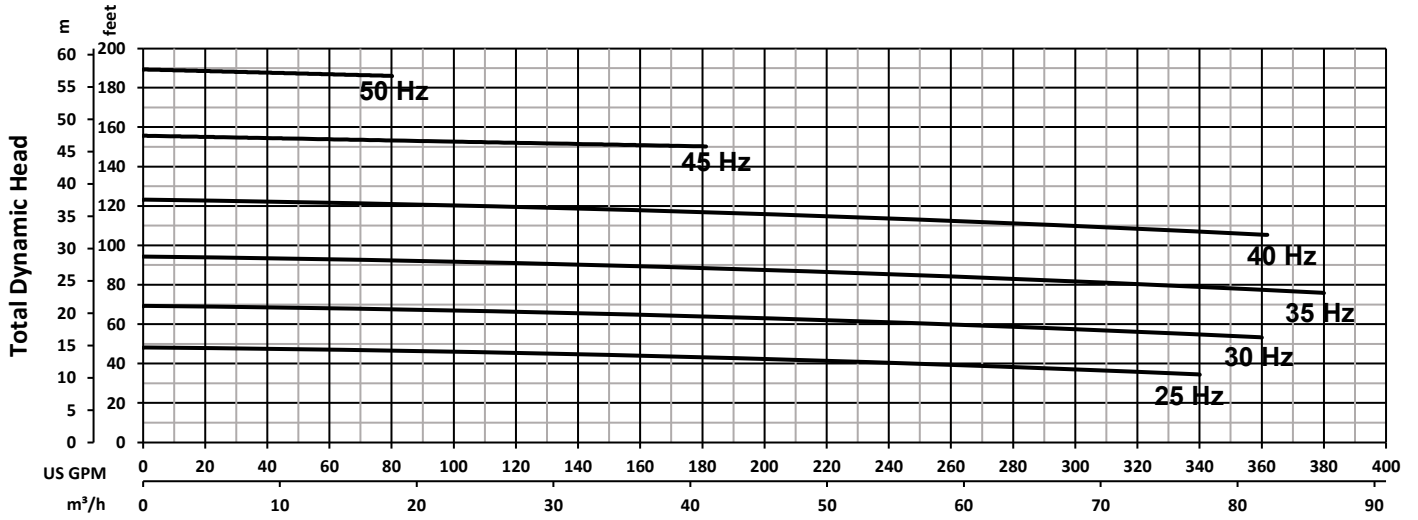

 INDUSTRIAL FLOW SOLUTIONS	PERFORMANCE CURVE			DS-A50-088	
	Tested with clean water Test Standard : HI 11.6 Gr 3B		Model	OW61R-2VV 11.0kW	Rev 1
			Motor	11.0kW / 14.75HP	Poles 2
	Impeller Ø	T2 200mm		Specifications subject to change without notice	

PERFORMANCE CURVE OW61R-2VV 15.0kW



 INDUSTRIAL FLOW SOLUTIONS	PERFORMANCE CURVE			DS-A50-075	
	Tested with clean water Test Standard : HI 11.6 Gr 3B	Model	OW61R-2VV 15.0kW		Rev 1
		Motor	15.0kW / 20.1HP	Poles 2	Date 6/10/2020
		Impeller Ø	T2 200mm		<small>Specifications subject to change without notice</small>

PERFORMANCE CURVE-TRIPLEX UNIT OWT61R-2VV 15.0kW-TRIPLEX

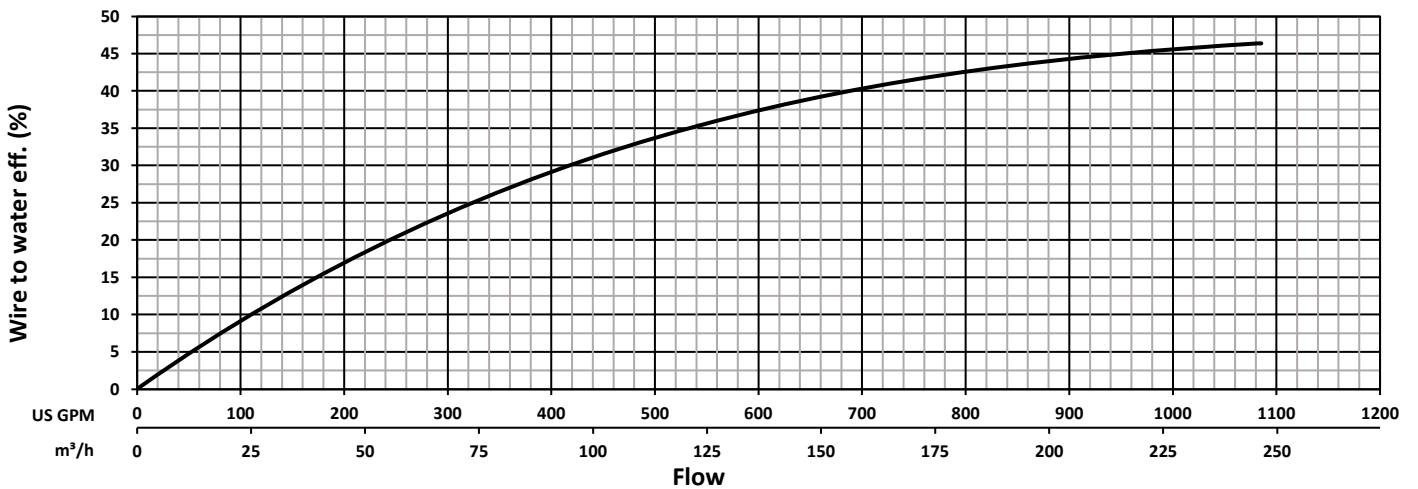
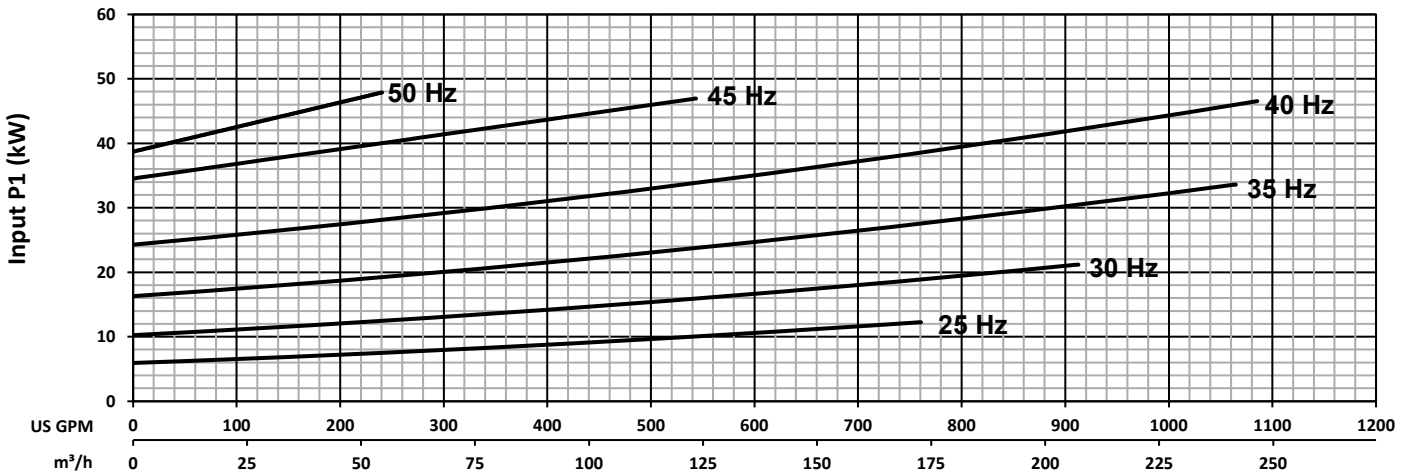
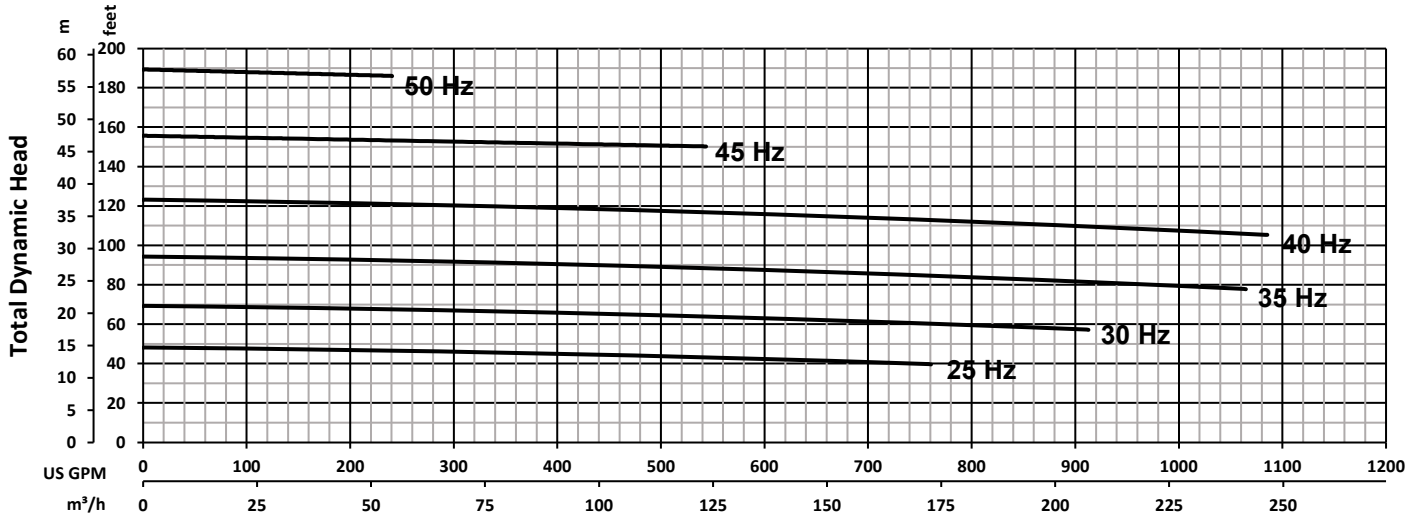

 INDUSTRIAL FLOW SOLUTIONS	PERFORMANCE CURVE-TRIPLEX UNIT			DS-A50-076	
	Tested with clean water Test Standard : HI 11.6 Gr 3B	Model	OWT61R-2VV 15.0kW-		Rev 1
		Motor	15.0kW / 20.1HP	Poles 2	Date 6/10/2020
		Impeller Ø	T2 200mm	Specifications subject to change without notice	

PERFORMANCE CURVE OW61R-2VV 18.5kW

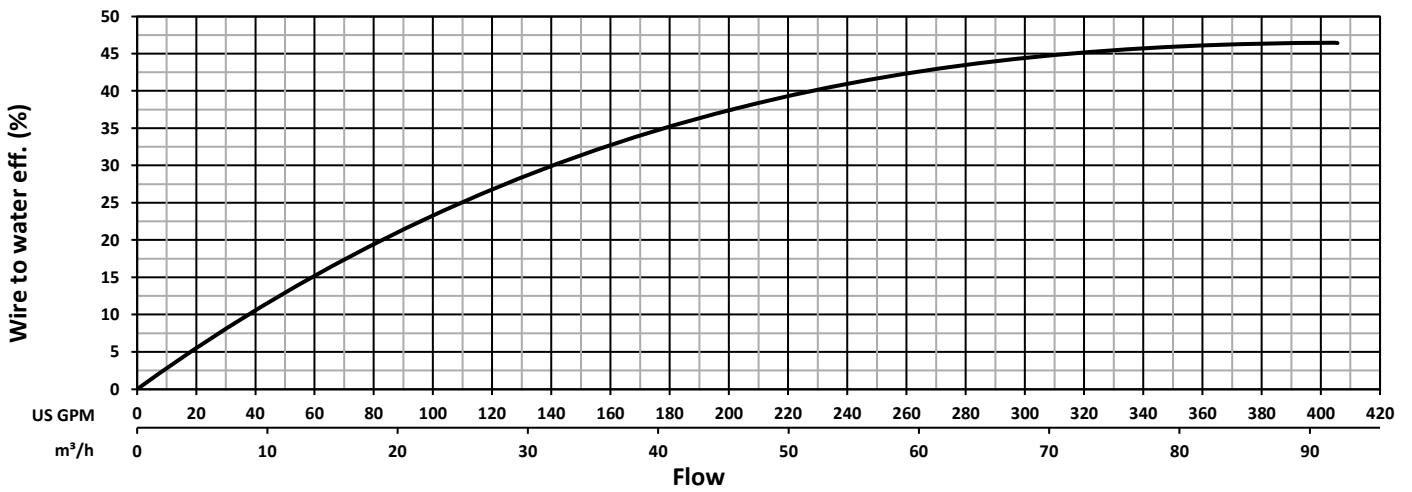
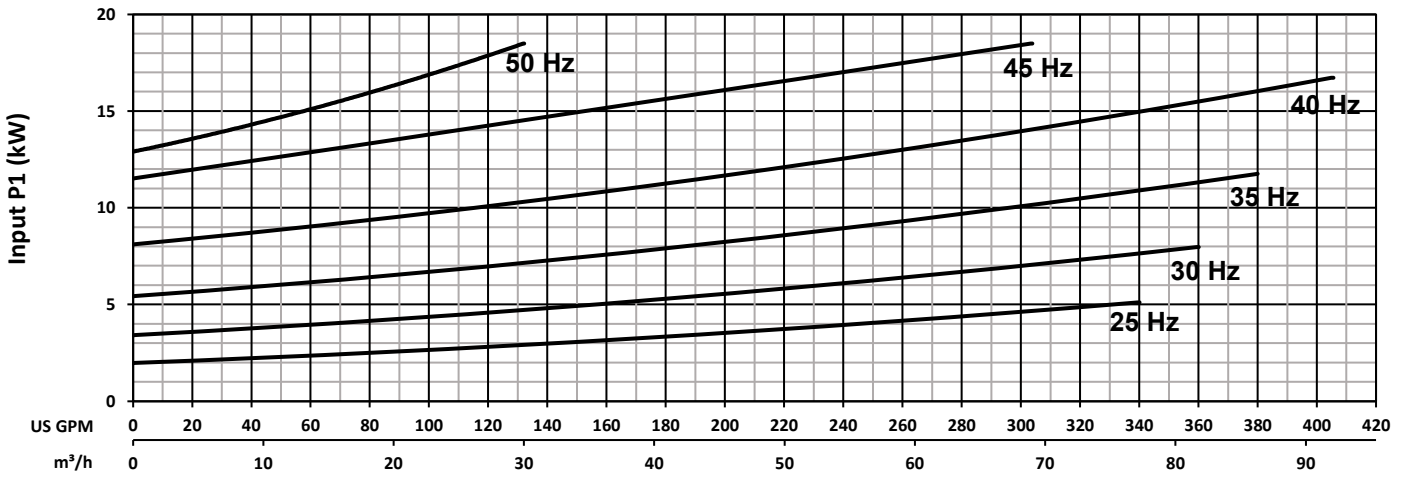
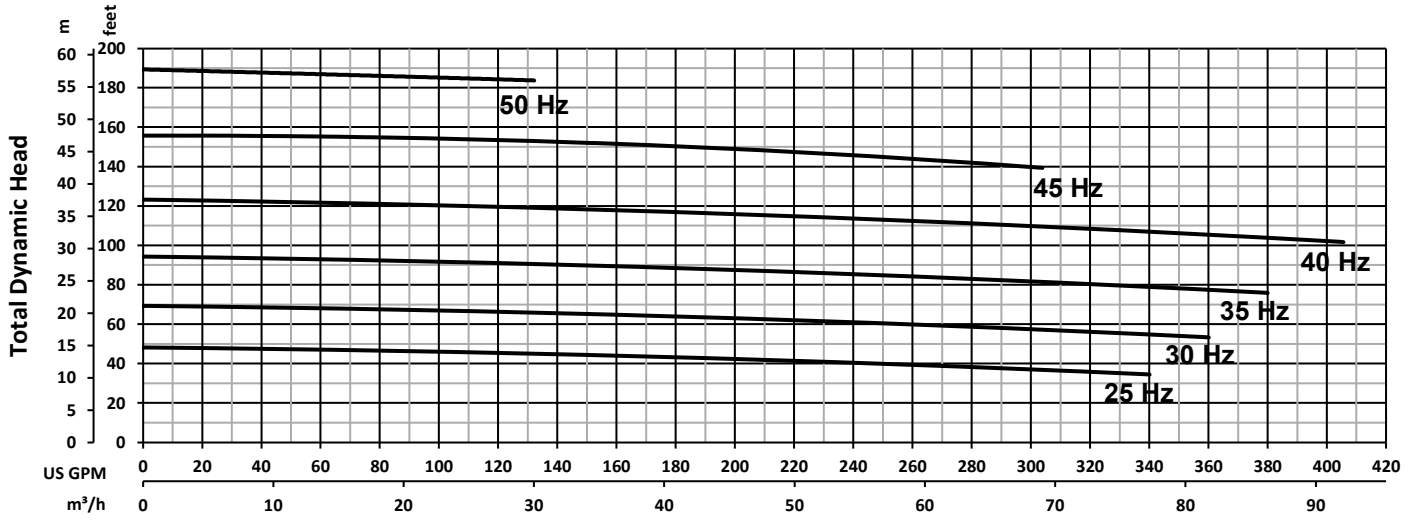

 INDUSTRIAL FLOW SOLUTIONS	PERFORMANCE CURVE			DS-A50-084
	Tested with clean water Test Standard : HI 11.6 Gr 3B		Model OW61R-2VV 18.5kW	Rev 1
			Motor 15.0kW / 24.8HP	Poles 2
			Impeller Ø T2 200mm	Date 6/10/2020
				Specifications subject to change without notice