

## DESIGN / CONSTRUCTION

Body	304L SS
External Hardware	304L SS
Gaskets	Buna-N
Motor Body	Cast Iron
Shaft Seal	Single Mechanical Seal
Impeller	110mm DIPCUT® Impeller Standard (Vortex or Channel optional)
Maximum Solid Size $\varnothing$	2.0" (55mm)

## MOTOR SPECIFICATIONS

Motor Design	4-Pole, 3-Phase Squirrel-Cage Motor 50Hz/60Hz
Motor Type	TEFC, IP67
Insulation Class	Class F
Motor Protection	Protected by VFD
Service Factor	1.15
Maximum Ambient Temp.	104°F (40°C)
Voltage Tolerance	±10%

## MOTOR DATA

Rated Power	230V FLA	460V FLA	575V FLA	Weight *
1.5kW / 2HP	6.8	3.4	2.7	185lb (84kg)
2.2kW / 3HP	9.4	4.7	3.8	194lb (88kg)

## DIMENSIONS (largest motor)

Inlet	5" ANSI 150#
Outlet	3" ANSI 150#
H1	11.0" (279mm)
H2	7.5" (192mm)
L	24.0" (610mm)
P	22.4" (569mm)

\* Total weight of unit

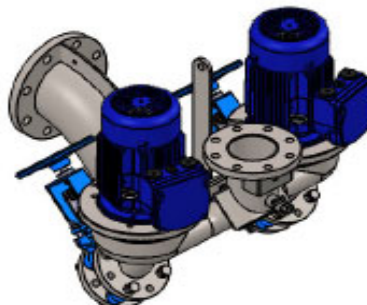
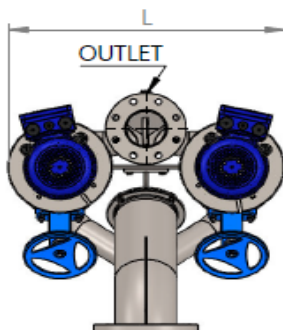
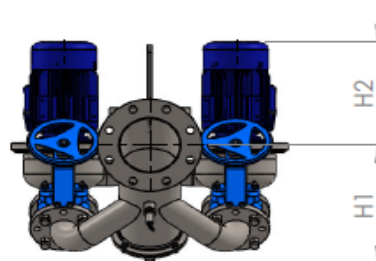
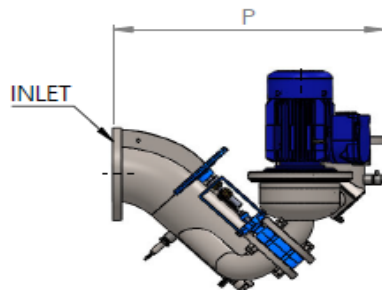

# PERFORMANCE CURVE OW11-4VV 1.5kW

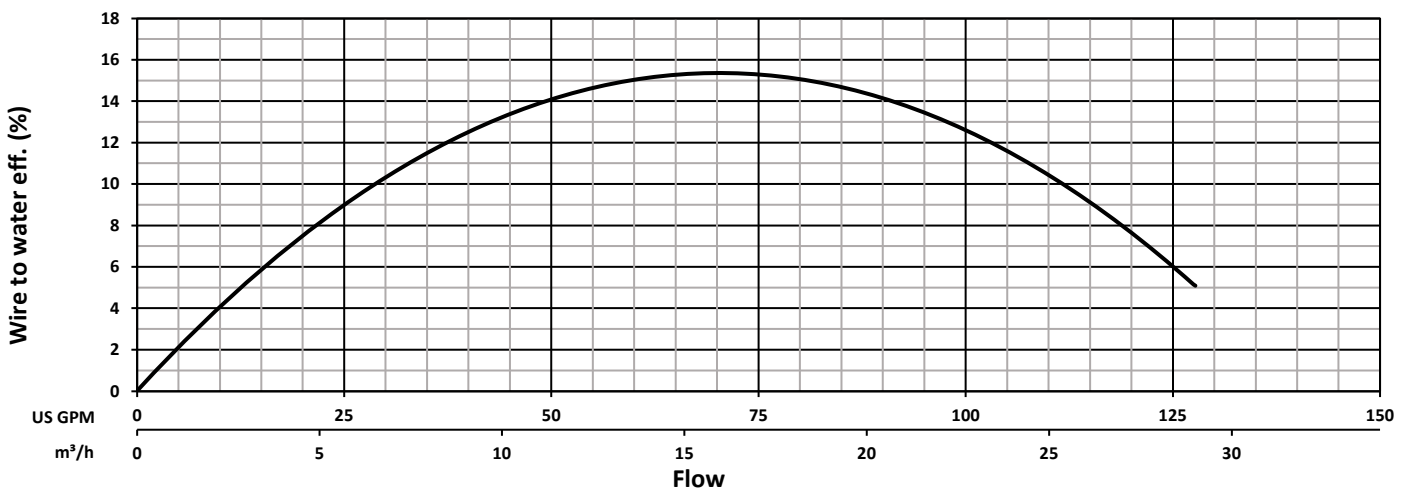
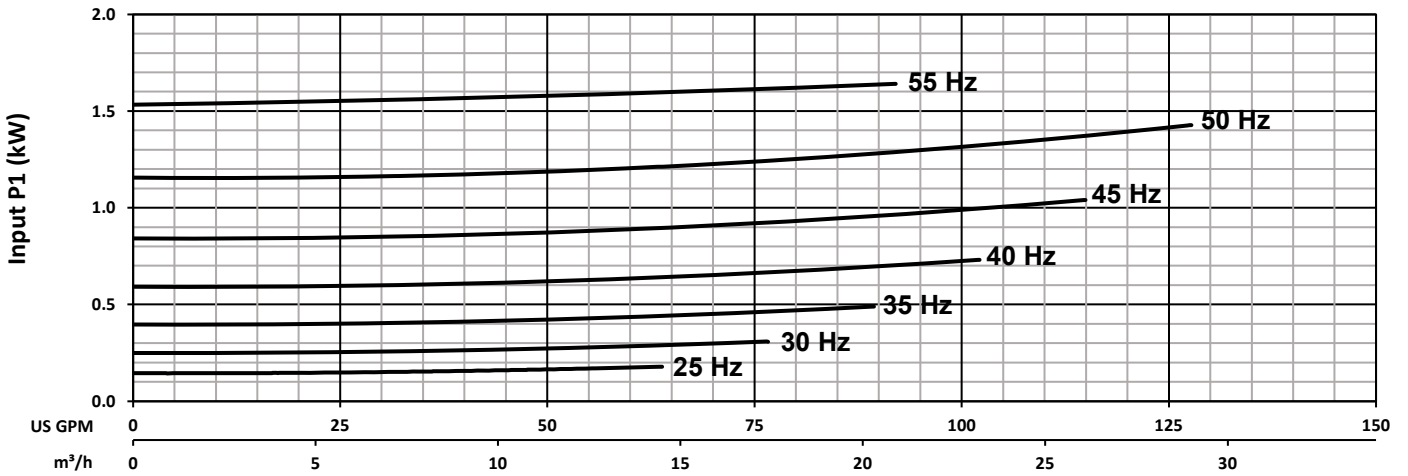
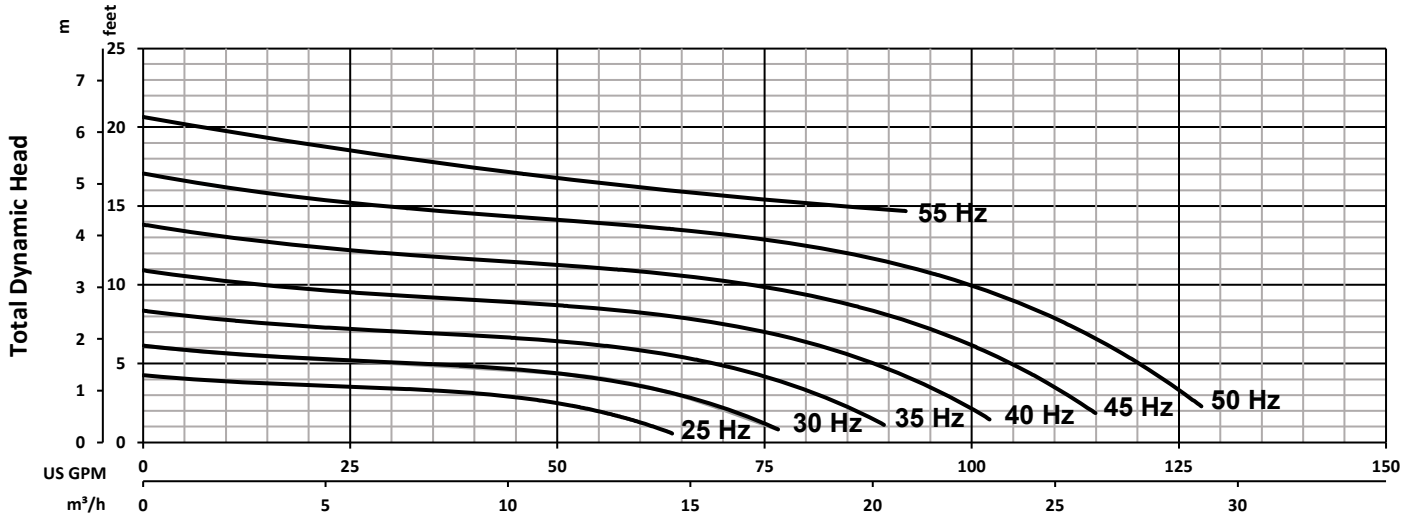

 <b>INDUSTRIAL FLOW SOLUTIONS</b>	<b>PERFORMANCE CURVE</b>			<b>DS-A50-002</b>
	Tested with clean water Test Standard : HI 11.6 Gr 3B		<b>Model</b> OW11-4VV 1.5kW	Rev --
	<b>Motor</b>	1.5 kW/2 HP	<b>Poles</b> 4	<b>Date</b> 2/27/2020
	<b>Impeller Ø</b>	110mm	Specifications subject to change without notice	