

---

# Installation, Operation And Maintenance Manual



## Stancor™ WCP Series Pumps

# Table of Contents

<b>Safety Guidelines</b>	<b>3</b>
<b>Safety Information</b>	<b>5</b>
<b>Maintenance</b>	<b>6</b>
<b>Nameplate format</b>	<b>6</b>
<b>Prior to Operation</b>	<b>7</b>
<b>Check the following points upon receipting of your pump:</b>	<b>7</b>
<b>Installation</b>	<b>7</b>
<b>Electrical Wiring</b>	<b>8</b>
Wiring	8
Cable	8
Grounding	8
<b>Wiring Diagrams</b>	<b>8</b>
<b>Operation</b>	<b>9</b>
<b>Maintenance</b>	<b>9</b>
<b>Exploded View</b>	<b>10</b>
<b>Troubleshooting</b>	<b>11</b>
<b>Disassembly and Assembly</b>	<b>12</b>
<b>Appendices:</b>	<b>13</b>
Technical Data: WCP	13
Specifications: WCP	13
Pump Curves: WCP	13
Outline Drawings: WCP	13
<b>Notes</b>	<b>14</b>

## Safety Guidelines

This instruction manual provides you with the information required to safely own and operate your product.

Retain these instructions for future reference.

The product you have purchased is of the highest quality workmanship and material and has been engineered to give you long and reliable service.

This product has been carefully tested, inspected, and packaged to ensure safe delivery and operation. Please examine your item(s) carefully to ensure that no damage occurred during shipment.

If damage has occurred, please contact the place of purchase. They will assist you in replacement or repair, if required.

**READ THESE INSTRUCTIONS CAREFULLY BEFORE ATTEMPTING TO INSTALL, OPERATE, OR SERVICE YOUR PRODUCT. KNOW THE PRODUCT'S APPLICATION, LIMITATIONS, AND POTENTIAL HAZARDS. PROTECT YOUR-SELF AND OTHERS BY OBSERVING ALL SAFETY INFORMATION. FAILURE TO COMPLY WITH THESE INSTRUCTIONS COULD RESULT IN PERSONAL INJURY AND/OR PROPERTY DAMAGE!**



### **WARNING: RISK OF ELECTRIC SHOCK.**

To reduce the risk of electric shock, be certain that it is connected only to a properly grounded, grounding type receptacle.

When a pump is in a basin, etc., do not touch motor, pipes or water until unit is unplugged or shut off. If your installation has water or moisture present, do not touch wet area until all power has been turned off. If shut-off box is not accessible, call the electric company to shut off service to the location, or call your local fire department for instructions. Failure to follow this warning can result in fatal electrical shock.

The flexible jacketed cord assembly mounted to the pump must not be modified in any way, except for shortening the cord to fit into a control panel. Any splice between the pump and the control panel must be made within a junction box and mounted outside of the basin and comply with the National Electrical Code. Do not use the power cord for lifting the pump.

The pump motor is equipped with an automatic resetting thermal protector and may restart unexpectedly. Protector tripping is an indication of motor overloading as a result of operating the pump at low heads (low discharge restriction), excessively high or low voltage, inadequate wiring, incorrect motor connections, or a defective motor or pump.

For a submersible well pump:

Reduced risk of electric shock during operation of this pump requires the provision of acceptable grounding:

When the means of connection to the supply-connection box is other than grounded metal conduit, ground the pump back to the service by connecting a copper conductor, at least the size of the circuit conductors supplying the pump, to the grounding screw provided within the wiring compartment.

This pump is provided with a means for grounding. To reduce the risk of electric shock from contact with adjacent metal parts, bond supply box to the pump-motor-grounding means and to all metal parts accessible at the well head, including metal discharge pipes, metal well casing, and similar parts, by means of:

An equipment-grounding conductor at least the size of the well-cable conductors, or the equivalent, that runs down the well with the well cable and

A clamp, a weld, or both when required, secured to the equipment-grounding lead, the equipment-grounding terminal, or the grounding conductor on the pump housing.

The equipment-grounding lead, when one is provided, is the conductor that has an outer surface of insulation that is green with or without one or more yellow stripes.

For a cord and plug-connected pump:

Risk of electric shock - This pump is supplied with a grounding conductor and grounding-type attachment plug. To reduce the risk of electric shock, be certain that it is connected only to a proper grounded, grounding type receptacle.

When use as a fountain pump, to reduce the risk of electric shock, use only on portable self-contained fountains no larger than 5 feet in any dimension. Read all instructions and Safety Guidelines thoroughly. Failure to follow the guidelines and instructions could result in serious bodily injury and/or property damage.

**DO NOT USE TO PUMP FLAMMABLE OR EXPLOSIVE FLUIDS SUCH AS  
GASOLINE,  
FUEL OIL, KEROSENE, ETC.  
FAILURE TO FOLLOW THIS WARNING CAN RESULT IN PERSONAL INJURY,  
DEATH AND/OR PROPERTY DAMAGE.**

During normal operation, this pump is immersed in water. Also, during rainstorms, water may be present in the surrounding area of the pump. Caution must be used to prevent bodily injury when working near the pump. Electrical power should be disconnected prior to touching, servicing or repairing the pump.

Do not run the pump in a dry basin. If the pump is run in a dry basin, the surface temperature of the pump will rise to a high level. This high temperature could cause skin burns if the pump is touched and will cause serious damage to your pump. Do not install in locations classified as hazardous in accordance with the National Electrical Code, ANSI/NFPA 70. Do not remove cord and strain relief. Do not connect conduit to pump.

## **Caution**

For best performance of check valves, when handling solids install in a horizontal position or at an angle of no more than 45°. Do not install check valve in a vertical position as solids may settle in valve and prevent opening on start-up. A gate valve should follow the check valve to allow periodic cleaning of the check valve or removal of the pump. The remainder of the discharge line should be as short as possible with a minimum of turns to minimize friction head loss. Sewage and effluent applications will require a separate sump vent. A connection is provided on top of the sump or cover which must be piped to the existing building vent or extended outside with its own standpipe.

When working on pump or switch, always unplug pump power cord in addition to removing or shutting off circuit breaker before working on pump.

## Safety Information

***Please read this manual thoroughly before operating the product and retain it for future reference.***

***Disregard of this warning could result in personal injury.***

# WARNING

 **WARNING:** Risk of electric shock - This pump is supplied with a grounding conductor and grounding-type attachment plug.

 To reduce the risk of electric shock, be certain that it is connected only to a properly grounded, grounding-type receptacle.

 **CAUTION:** This pump has been evaluated for use with water only.

 Do not operate the product near potentially explosive environment.

 Do not use the product in the presence of flammable liquids or gases.

 Always turn off the power, before inspection, maintenance, and adjustment.

 Never attempt to change the settings of all protective devices without consulting with a STANCOR representative.

 The product is designed for moving wastewater, raw and clean water.

 The following shall not be handled for the pump and your safety:

- i) Flammable, toxic, abrasive, crystallizing and polymerizing liquid.
- ii) Liquid chemicals and food, alkaline and corrosive liquid.
- iii) High temperature, high viscosity and high solid matter content liquid.

 Protect the electric plug or the end of the power cable from invasive moisture at all times.

 Never touch the piping or electrical connections while the pump is running.

 Never touch the water while the pump is under operation!

 Never put the pump into operation if it has been partially dismantled.

 Never run pump without water, do not operate the pump out of water or insufficient water.

 Do not use the pump if the power cable is damaged.

If you have any question, please contact our representative or company.

***This pump is NOT intended for use where water is occupied by people.***

## Maintenance

If the pump does not operate properly or trouble shooting doesn't work, consult your pump dealer or take pump to a Stancor authorized service center.

## Nameplate format

**STANCOR**  
Pump & Control  
Solutions

NO. \_\_\_\_\_

MODEL \_\_\_\_\_

Frequency	Hz	Pole	P
Head	ft.	Flow	gpm
Output	HP	Phase	φ
Voltage	V	Current	A
Revolution	/min	Max. AMP	40°C
IP		Insulation	Class

**MADE IN TAIWAN**

Name	Description
Serial No.	Serial Number
Model	Pump Model
Frequency	Power Frequency (Hz)
Head	Maximum Pressure Head (m)
Output	Pump Output BHP (Hp)
Voltage	Operating Voltage (V)
Revolution	Rotational Speed
Discharge	Discharge Size (inch)
Flow	Maximum Capacity
Phase	Number of Phase (φ)
FLA	Full Load Current (A)
Weight	Pump Weight (Lbs)
IP	Ingress Protection
Insulation	Insulation Class

# Prior to Operation

## Check the following points upon receipt of your pump:

Is the pump exactly what you ordered? Check nameplate. It is especially important that you check whether the pump is to be used with 50 or 60 Hz.

*Has any damage occurred during shipment? Are any bolts or nuts loose?*

*Have all necessary accessories been supplied?*

We recommend that you keep a spare pump on hand in case of emergencies. Keep this instruction manual in a place for future reference.

Check the nameplate for your pump's head (HEAD), volume (CAPACITY), speed (SPEED), motor voltage and current.

# Installation

## 1. Check the following before beginning installation.

Insulation resistance measurement:

With the motor and cable (excluding the power supply cable) immersed in water, use a Megger to measure the insulation resistance between ground and each phase of the motor, and again between each phase of the motor. The Megger should indicate an insulation resistance of not less than 20 mega ohms. While making the measurement, keep the power supply cable off the ground.

We recommend that an auxiliary pump be kept on hand in case of emergency.

## 2. Installation

For automatic operation, pump must be plugged or wired into a remote float switch or liquid level controller. Installation instructions are included with all our switches and controllers and should be referred to for installation.

Installation and servicing shall be conducted by qualified person /people. Pump will run continuously if plugged directly into an electrical outlet. Care should be taken to prevent pump running in a dry sump.

Pump must be installed with local plumbing codes. Pump must be placed on a hard level surface. Never place pump directly on clay, earth or gravel surfaces.

Pump can be installed with ABS, PVC, polyethylene or galvanized steel pipe.

Proper adapters are required to connect plastic pipe to pump.

Always install a union in the discharge line, just above the sump pit, to allow for easy removal of the pump for cleaning or repair. A check valve must be used in the discharge line to prevent backflow of liquid into the basin.

The check valve should be a free-flow valve that will easily pass solids.

**Under no circumstances should cable be pulled while the pump is being transported or installed.** Attach a chain or rope to the grip and install the pump.

This pump must not be installed on its side or operated a dry condition. Ensure that it is installed upright on a secure base.

Install the pump at a location in the tank where there is the least turbulence.

**If there is a flow of liquid inside the tank, support the piping where appropriate.** Install piping so that air will not be entrapped. If piping must be installed in such a way that air pockets are unavoidable, install an air release valve wherever such air pockets are most likely to develop.

Do not permit end of discharge piping to be submerged, as backflow will result when the pump is shut down.

**Non-automatic pumps have an automatic operating system pump operating water level near the minimum operating level as the automatic cut-off switch incorporated inside the motor will be activated.**

**To avoid dry operation, install an automatic operating system, as required and maintain a safe operating water level (C.W.L.: Continuous Water Level).**

**For automatic pumps (models A), install the floats as required.** The pump may not start if a floats switch touches the wall of the water tank or the piping. Install the floats so that this will not happen.

# Electrical Wiring

Check local electrical and building codes before installation. The installation must be in accordance with their regulations as well as the most recent National Electrical Code (NEC).

Pump should be connected or wired to its own circuit with no other outlets or equipment in the circuit line. Fuses and circuit breaker should be of ample capacity in the electrical circuit.

## Wiring

- A) Wire as indicated for the appropriate start system as shown in Fig-3 for single phase version and Fig-4 for three phases.
- B) Loose connections will stop the pump. Make sure all electrical connections secure.

## Cable

**WARNING:** Never let the end of the cable contact water.

- C) If the cable is extended, do not immerse the splice in water.
- D) Fasten the cable to the handle
- E) Install the cable so that it will not overheat. Overheating can be caused by coiling the cable and exposing it to direct sun light.

## Grounding

As shown in Fig-3 & Fig-4 ground the green wire. Under no circumstances should the green wire be connected to the power supply directly.

## Wiring Diagrams

**Fig -3**

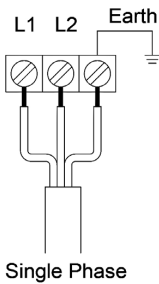

L1	L2	L3	Earth
Brown (Red)	Blue (White)	Black	Green/Yellow (Green)

Single Phase

**Fig -4**

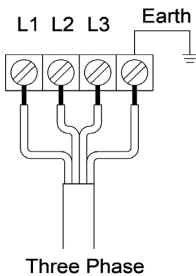

Three Phase

L1	L2	L3	Earth
Brown (Red)	Blue (White)	Black	Green/Yellow (Green)



# Operation

## 1. Before starting the pump

1. After completing installation, measure the insulation resistance again as described in Installation.
2. Check water level.

If the pump is operated continuously for an extended period in a dry condition or at the lowest water level, the motor protector will be shut off the power. Constant operating in above condition will shorten pump lifetime. Do not start the pump again in such a situation before the motor has completely cooled.

## 2. Test operation

1. Turn the operating switch on and off a couple of times to check switch function.
2. For the SSDS-A pumps  
Floating switch must be raised for the pump to start.
3. Next, check direction of rotation. If discharge volume is low or unusual sounds are heard when the pump is operating, rotation direction is reversed. When this happens, reverse two of the wires.

# Maintenance

Check pressure, output, voltage, current and other specifications. Unusual readings may indicate. Refer to Troubleshooting and correct as soon as possible.

## 1. Daily inspections

Check current and ammeter fluctuation daily. If ammeter fluctuation is great, even though within the limits of pump rating, foreign matter may be clogged the pump. If the volume of liquid discharged falls suddenly, foreign matter may be blocked the suction inlet.

## 2. Regular inspections

### Monthly inspections

Measure the insulation resistance. The value should be more than 1M ohm. If resistance starts to fall rapidly even with an initial indication of over 1M ohm, this may be an indication of trouble and repair work is required.

### Annual inspections

To prolong the service life of the mechanical seal by replacing the oil in the mechanical seal chamber once a year. Water mixed the oil or cloudy textures are indications of a defective mechanical seal requiring replacement. When replacing the oil, lay the pump on its side with filler plug on top. Fill suitable amount turbine oil No.32 (ISO VG-32).

## Inspections at 3-5-year intervals

Conduct an overhaul of the pump. These intervals will help to avoid possible failure in future.

## 3. Parts need to be replaced

Replace the appropriate parts when the following conditions appear.

Replaceable Part	Mechanical Seal	Oil filler plug gasket	Lubricating oil
Condition	Oil in mechanical seal chamber	Inspect or replace the oil	Oil is clouded or dirty
Frequency	Annual	Half a year	Half a year

**Note:** Above replacement schedule is based on normal operating conditions.

## Exploded View

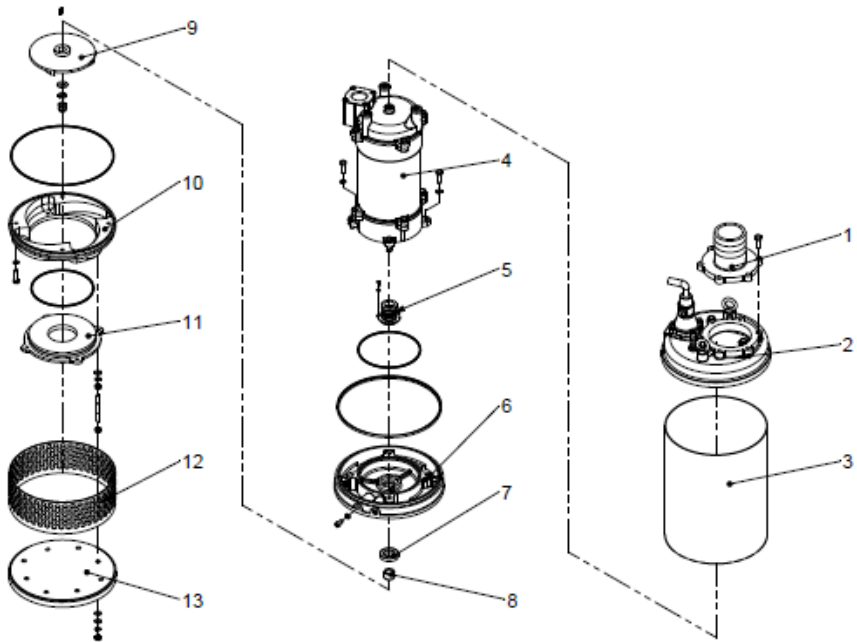

Pos.No	Denomination	Pos.No	Denomination
1	Discharge	8	Shaft sleeve
2	Upper cover	9	Impeller
3	Outer case	10	Pump casing
4	Motor	11	Inlet plate
5	Mech. seal	12	Strainer
6	Seal bracket	13	Base plate
7	Oil seal		

## Troubleshooting

Trouble	Cause	Remedy
<b>Does not start. Starts, but immediately stops.</b>	(1) Power failure	(1)-(3) Contact electric power company and devise counter-measures
	(2) Large discrepancy between power source and voltage	
	(3) Significant drop in voltage	
	(4) Motor phase malfunction	(4) Inspect electric circuit
	(5) Electric circuit connection faulty	(5) Correct wiring
	(6) Faulty connection of control circuit	(6) Inspect connections and magnetic coil
	(7) Fuses is blown	(7) Check circuit then replace fuse
	(8) Faulty magnetic switch	(8) Replace with correct one
	(9) Water is not at level indicated by Float	(9) Raise water level
	(10) Float is not in appropriate level	(10) Adjust the position of float
	(11) Float is not effective	(11) Repair or replace
	(12) Short circuit breaker is functioning	(12) Repair location of short circuit
	(13) Foreign matter clogging pump	(13) Remove foreign matter
	(14) Motor burned out	(14) Repair or replace
	(15) Motor bearing broken	(15) Repair or replace
<b>Operates, but stops after a while.</b>	(1) Prolonged dry operation has activated motor protector	(1) Raise water level to C.W.L
	(2) High liquid temperature has activated motor protector	(2) Lower liquid temperature
	(3) Reverse rotation	(3) Correct rotation
<b>Does not pump. Inadequate volume.</b>	(1) Reverse rotation	(1) Correct rotation (see Operation)
	(2) Significant drop in voltage	(2) Contact electric power company
	(3) Operating a 60Hz pump with 50Hz	(3) Check nameplate
	(4) Discharge head is high	(4) Recalculate and adjust
	(5) Large piping loss	(5) Recalculate and adjust
	(6) Low operating water level causes air suction	(6) Raise water level or lower pump
	(7) Leaking from discharge piping	(7) Inspect, repair
	(8) Clogging of discharge piping	1(8) Remove foreign matter
	(9) Foreign matter in suction inlet	(9) Remove foreign matter
	(10) Foreign matter clogging pump	(10) Remove foreign matter
	(11) Worn impeller	(11) Replace impeller
<b>Over current</b>	(1) Unbalanced current and voltage	(1) Contact electric power company
	(2) Significant voltage drop	(2) Contact electric power company and devise counter-measure
	(3) Motor phase malfunction	(3) Inspect connections and magnetic switch
	(4) Operating 50Hz pump on 60Hz	(4) Check nameplate
	(5) Reverse rotation	(5) Correct rotation (see Operation2)
	(6) Low head. Excessive volume of water	(6) Replace pump with high head pump
	(7) Foreign matter clogging pump	(7) Remove foreign matter
	(8) Motor bearing is worn out or damaged	(8) Replace bearing
<b>Pump vibrates Excessive operating noise.</b>	(1) Reverse rotation	(1) Correct rotation
	(2) Pump clogged with foreign matter	(2) Disassemble and remove foreign matter
	(3) Piping resonates	(3) Improve piping
	(4) Strainer is closed too far	(4) Open strainer

# Disassembly and Assembly

## 1. Disassembly

When disassembling pump, have a piece of cardboard or wooden board ready to place the different parts on as you work. Do not pile parts on top of each other. They should be laid out neatly in rows.

The "O" ring and gasket cannot be used again once they are removed. Have replacement parts ready.

Disassemble in the following order, referring to the sectional view.

Be sure to cut off power source before disassembly.

1. Remove pump casing bolts, raise the motor section and remove pump casing.
2. Remove shaft head bolt and impeller.
3. Remove oil filler plug and drain lubricating oil.
4. Remove intermediate casing bolts and oil chamber.  
(Remember that any lubricating oil remaining in the mechanical seal chamber will flow out.)
5. Carefully remove mechanical seal, beware of not to scratch sliding surface of motor shaft.

## 2. Assembly

Re-assemble in reverse order of disassembly.

Be careful of the following points.

1. During re-assembly, rotate the impeller by hand and check for smooth rotation. If rotation is not smooth, perform steps (3) through (5) again.
2. Upon completion of re-assembly step (1) rotate the impeller by hand from the suction inlet and check that it rotates smoothly without touching the suction cover before operating the pump.

**Please order "O" rings, packing, shaft seals and other parts from, your dealer.**

## Appendices:

### Technical Data: WCP

WCP-400 HH	DS-A28-001
WCP-400 HV	DS-A28-009
WCP-1100 HH	DS-A28-005

### Specifications: WCP

WCP-400 HH	DS-A28-002
WCP-400 HV	DS-A28-010
WCP-1100 HH	DS-A28-006

### Pump Curves: WCP

WCP-400 HH	DS-A28-003
WCP-400 HV	DS-A28-011
WCP-1100 HH	DS-A28-007

### Outline Drawings: WCP

WCP-400 HH	DS-A28-004
WCP-400 HV	DS-A28-012
WCP-1100 HH	DS-A28-008

### List of Parts: WCP

WCP-400 HH	DS-A28-015
WCP-400 HV	DS-A28-017
WCP-1100 HH	DS-A28-013

### Exploded View: WCP

WCP-400 HH	DS-A28-016
WCP-400 HV	DS-A28-018
WCP-1100 HH	DS-A28-014

# Notes

