

**DESIGN / CONSTRUCTION**

Body	304L SS
External Hardware	304L SS
Gaskets	Buna-N
Motor Body	Cast Iron
Shaft Seal	Single Mechanical Seal
Impeller	180mm DIP CUT® Impeller Standard (Vortex or Channel optional)
Maximum Solid Size ϕ	3.0" (76.2mm)

MOTOR SPECIFICATIONS

Motor Design	4-Pole, 3-Phase Squirrel-Cage Motor 50Hz/60Hz
Motor Type	TEFC, IP67
Insulation Class	Class F
Motor Protection	Protected by VFD
Service Factor	1.15
Maximum Ambient Temp.	104°F (40°C)
Voltage Tolerance	±10%

MOTOR DATA

Rated Power	208V FLA	230V FLA	460V FLA	575V FLA	Weight *
2.2kW / 3HP	10.4	9.4	4.7	3.8	329lb (149kg)
3kW / 4HP	14.4	13	6.5	5.2	344lb (156kg)
4kW / 5.4HP	18.4	16.6	8.3	6.6	375lb (170kg)
5.5kW / 7.4HP	23.9	21.6	10.8	8.6	419lb (190kg)
7.5kW / 10HP	32.1	29	14.5	11.6	463lb (210kg)

DIMENSIONS (largest motor)

Inlet	6" ANSI 150#
Outlet	4" ANSI 150#
H1	14.7" (374mm)
H2	17.5" (445mm)
L	33.6" (854mm)
P	29.5" (750mm)

* Total weight of unit

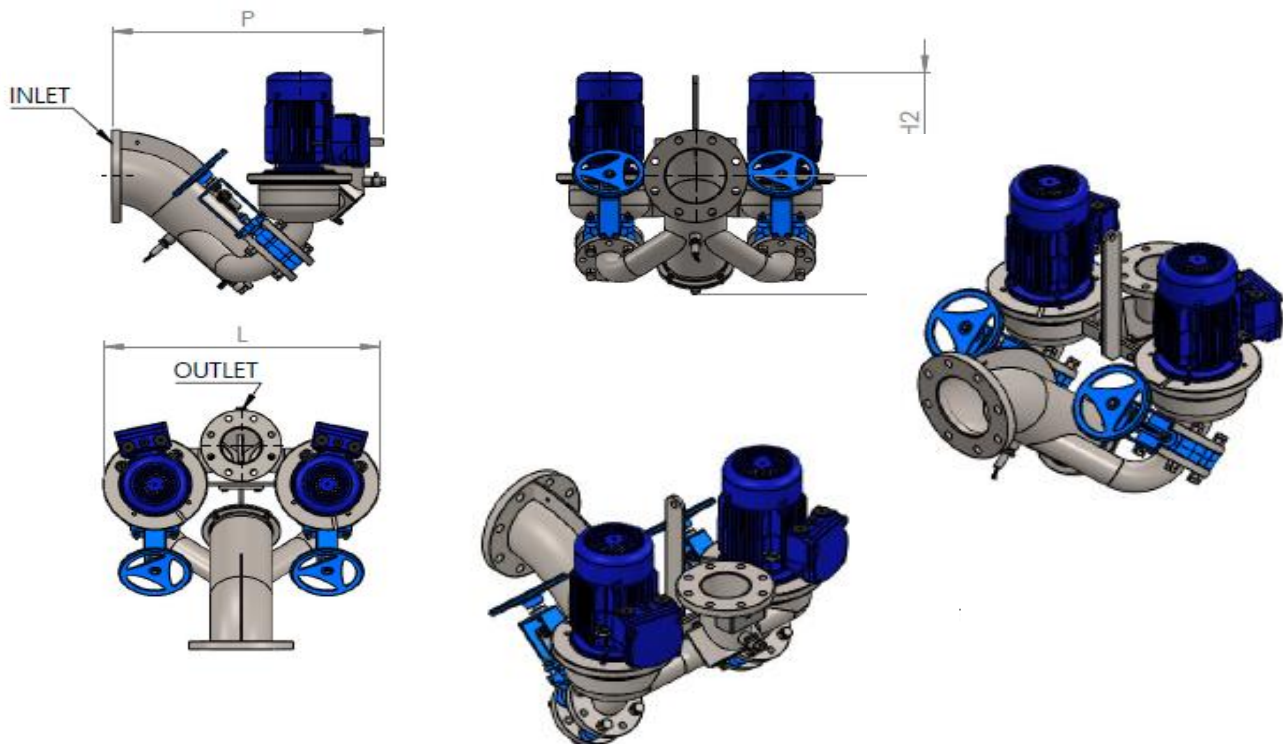

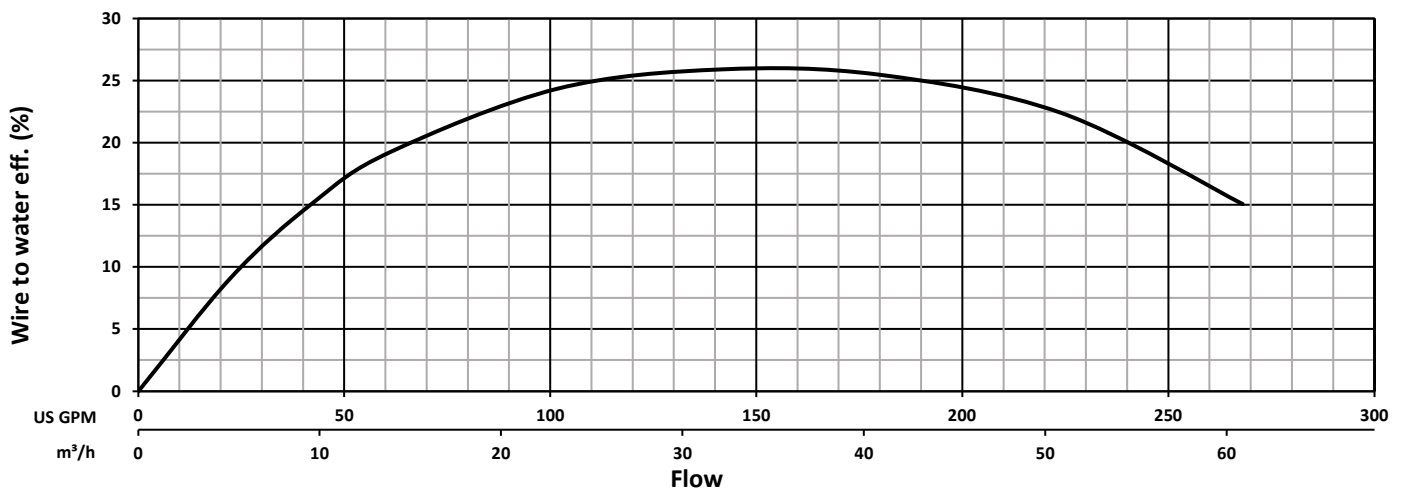
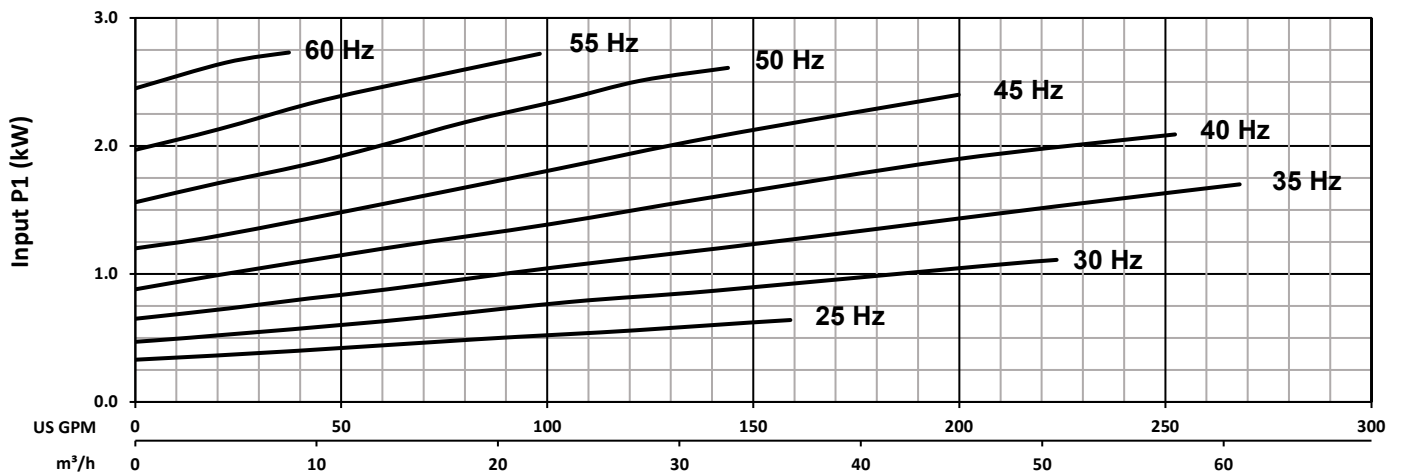
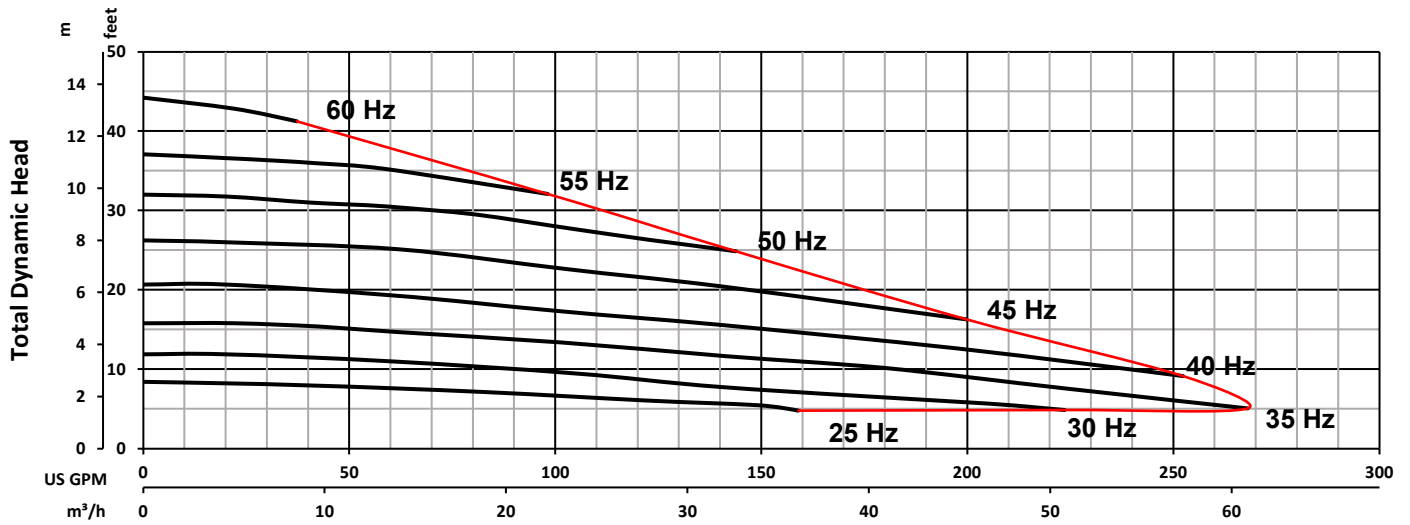

PERFORMANCE CURVE OW31-4VV DC 2.2kW

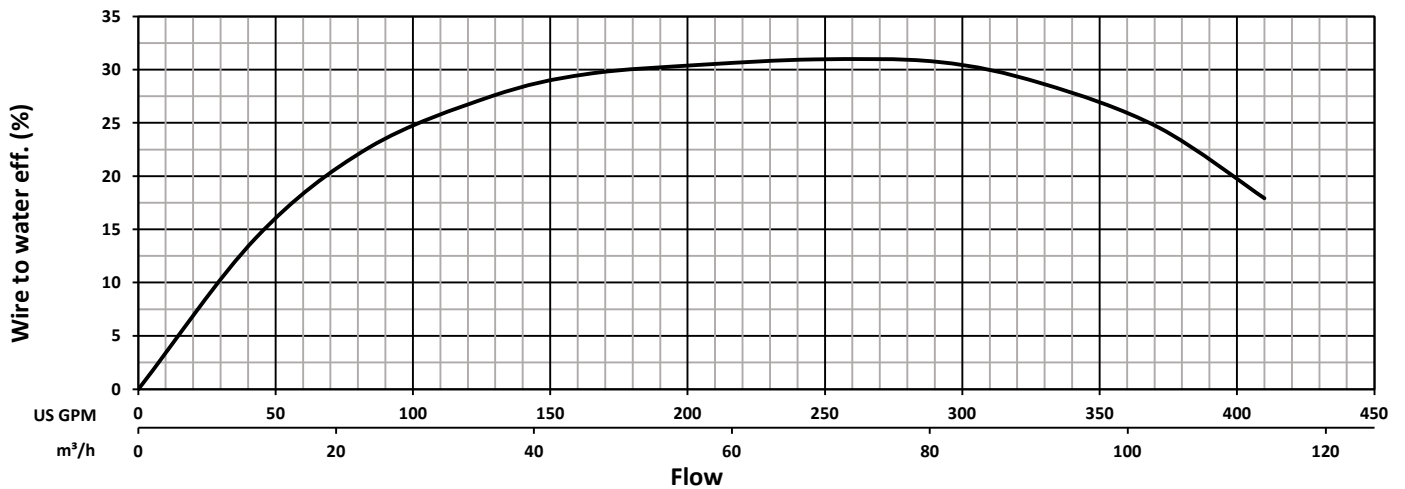
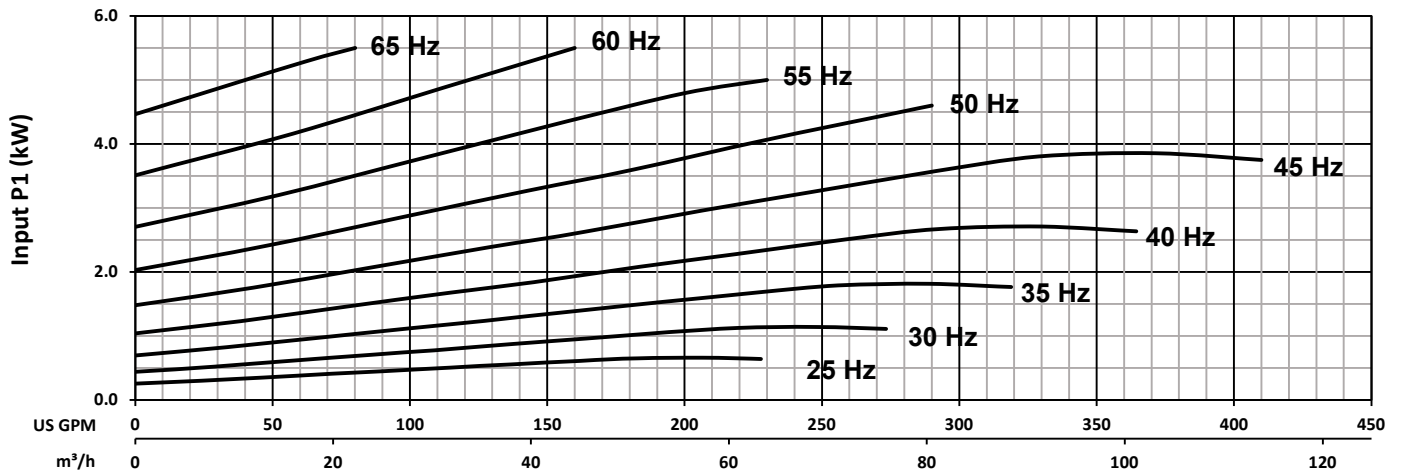
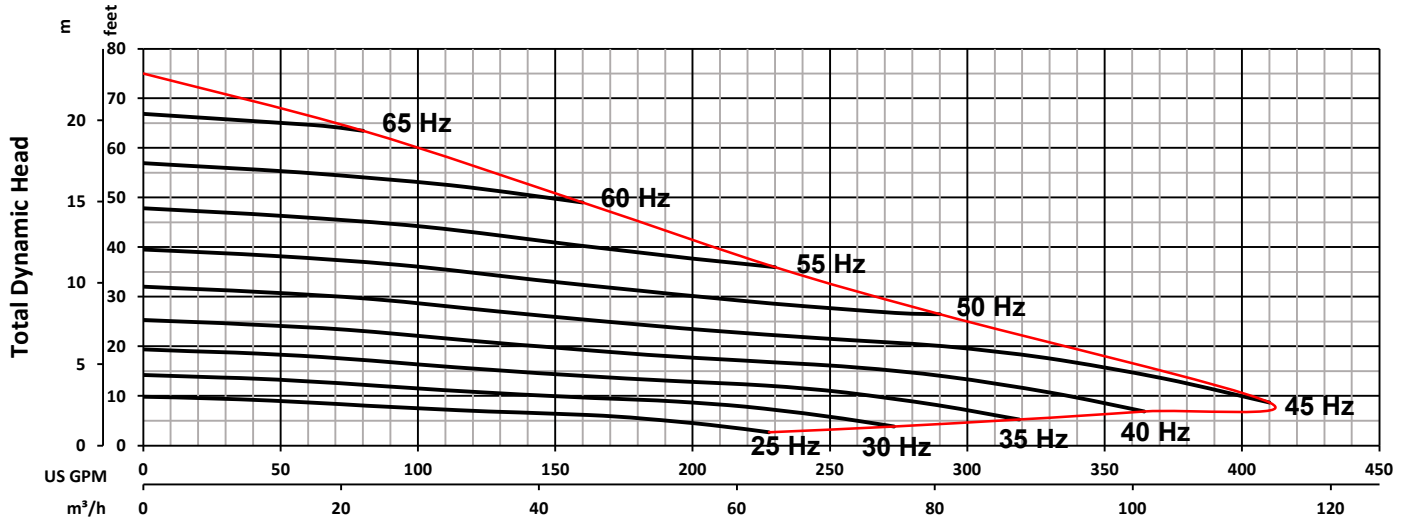

 INDUSTRIAL FLOW SOLUTIONS	PERFORMANCE CURVE OW31-4VV DC 2.2kW			DS-A50-210	
	Tested with clean water Test Standard : HI 11.6 Gr 3B		Model	OW31-4VV	
			Motor	2.2kW / 2.9HP	Poles 4
	Impeller Ø		165x40mm	Specifications subject to change without notice	
			Rev 1	IT	
			Date 6/21/2021		

PERFORMANCE CURVE OW31-4VV DC 4kW



 INDUSTRIAL FLOW SOLUTIONS	PERFORMANCE CURVE OW31-4VV DC 4kW			DS-A50-202
	Tested with clean water Test Standard : HI 11.6 Gr 3B		Model	OW31-4VV
			Motor	4kW / 5.4HP
			Impeller	180x40mm
Specifications subject to change without notice				

PERFORMANCE CURVE OW31-4VV DC 3kW

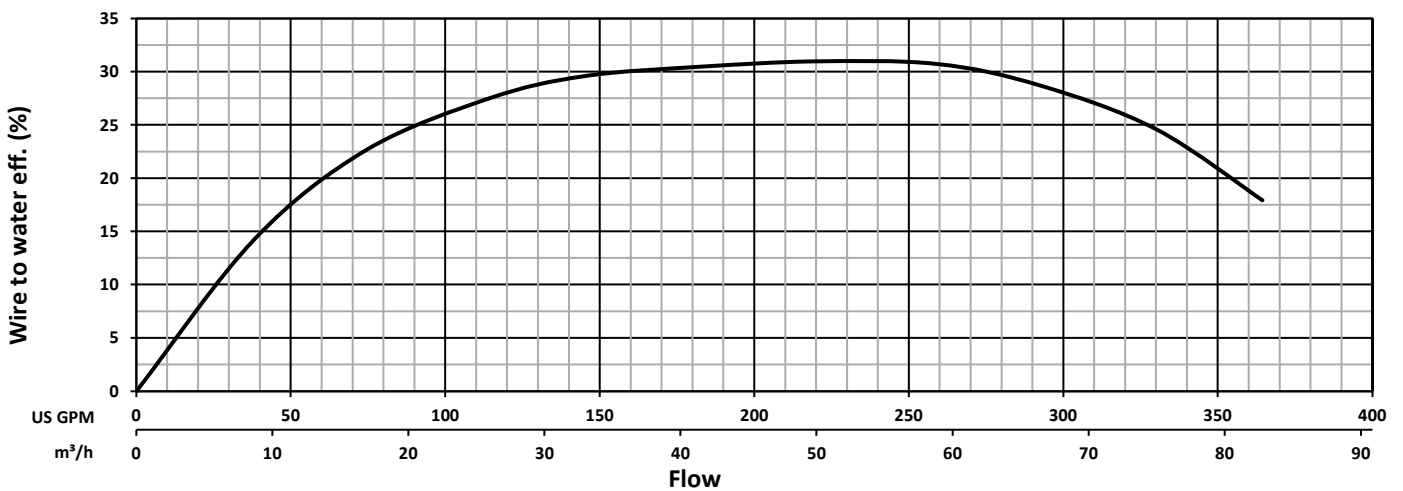
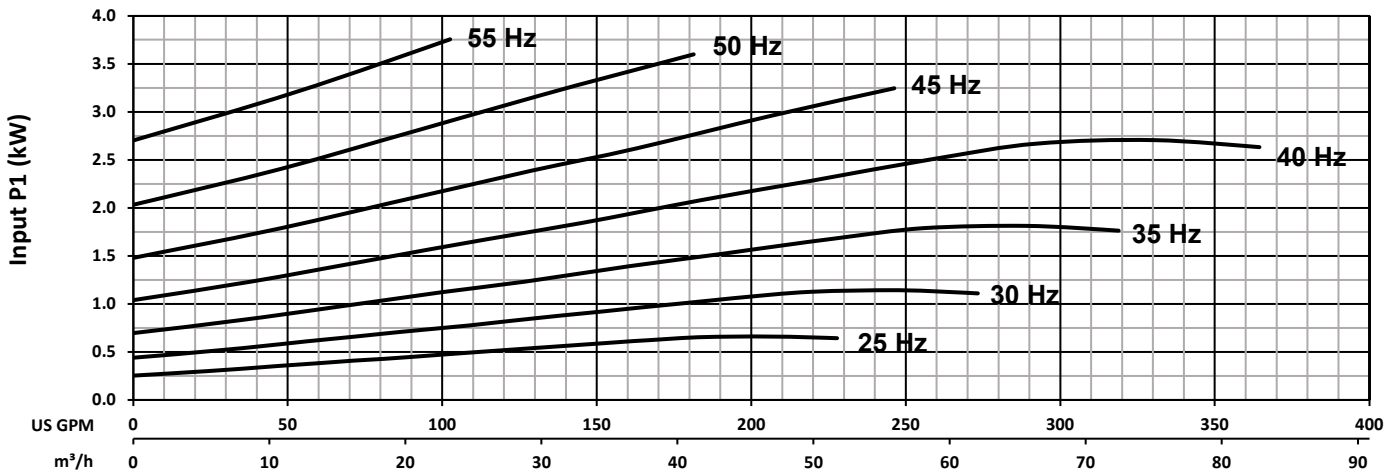
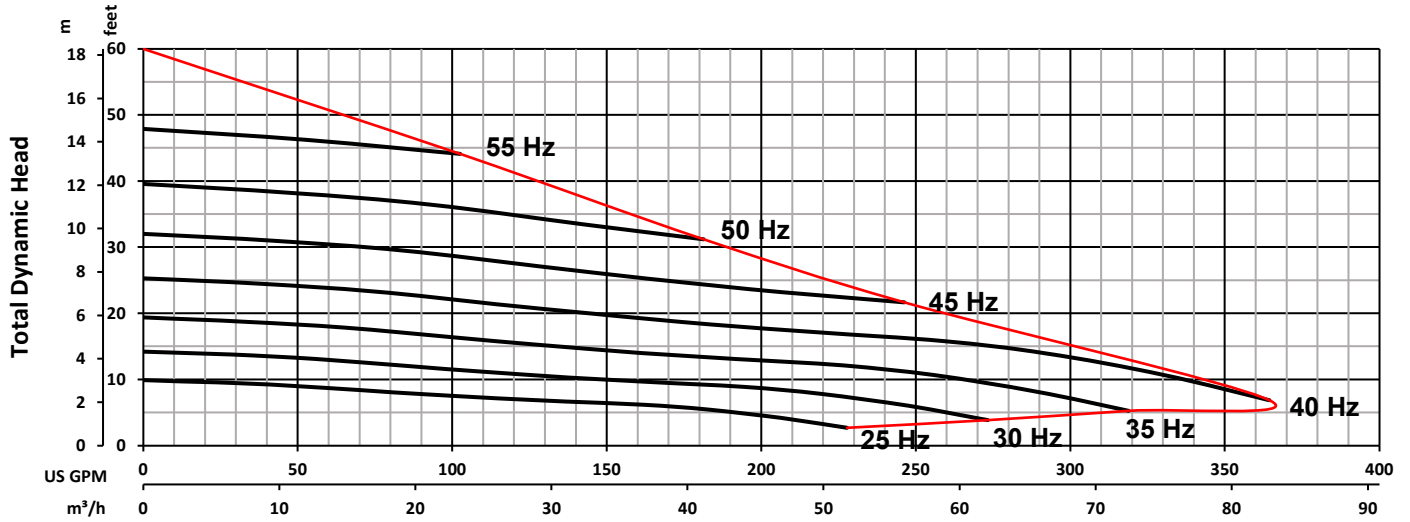

 INDUSTRIAL FLOW SOLUTIONS	PERFORMANCE CURVE OW31-4VV DC 3kW			DS-A50-201	
	Tested with clean water Test Standard : HI 11.6 Gr 3B		Model	OW31-4VV	
			Motor	3kW / 4HP	Poles 4
			Impeller	180x40mm	Specifications subject to change without notice
				Rev --	IT
				Date 3/24/2021	

PERFORMANCE CURVE OW31-4VV DC 7.5kW

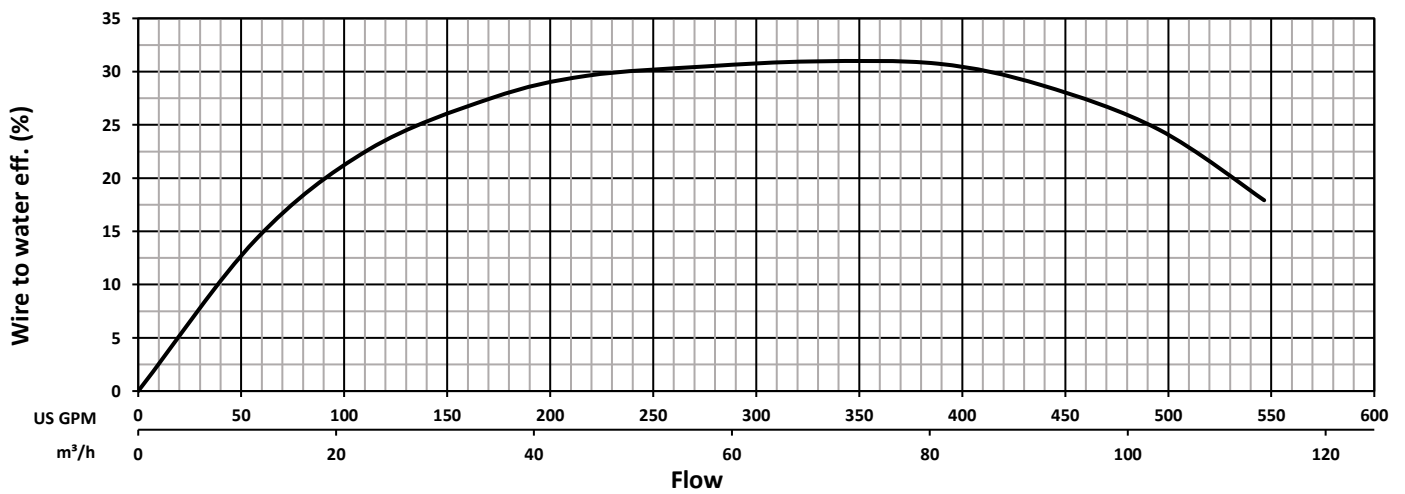
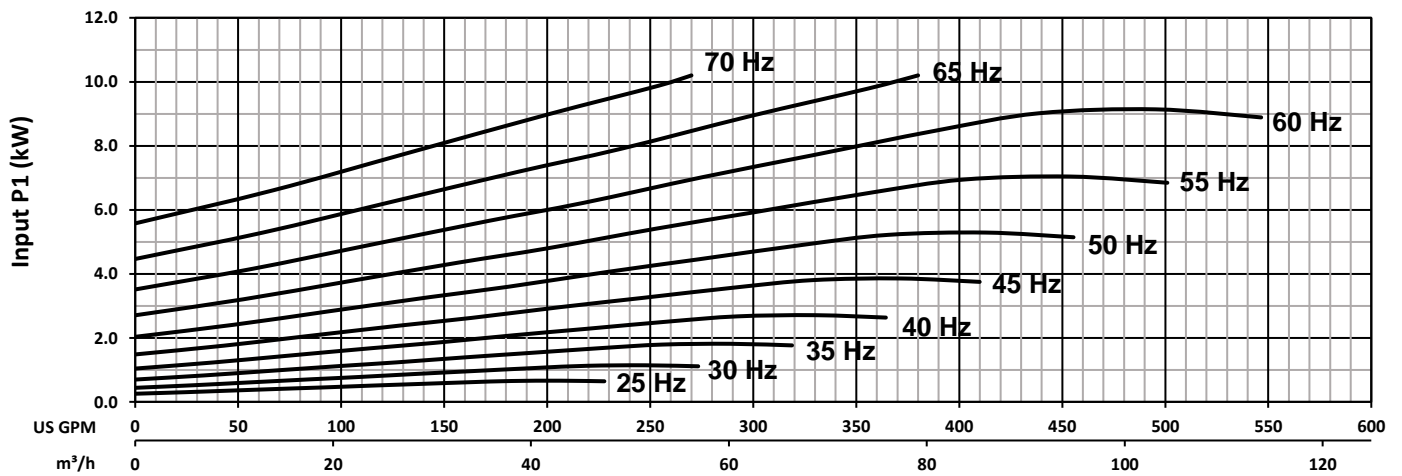
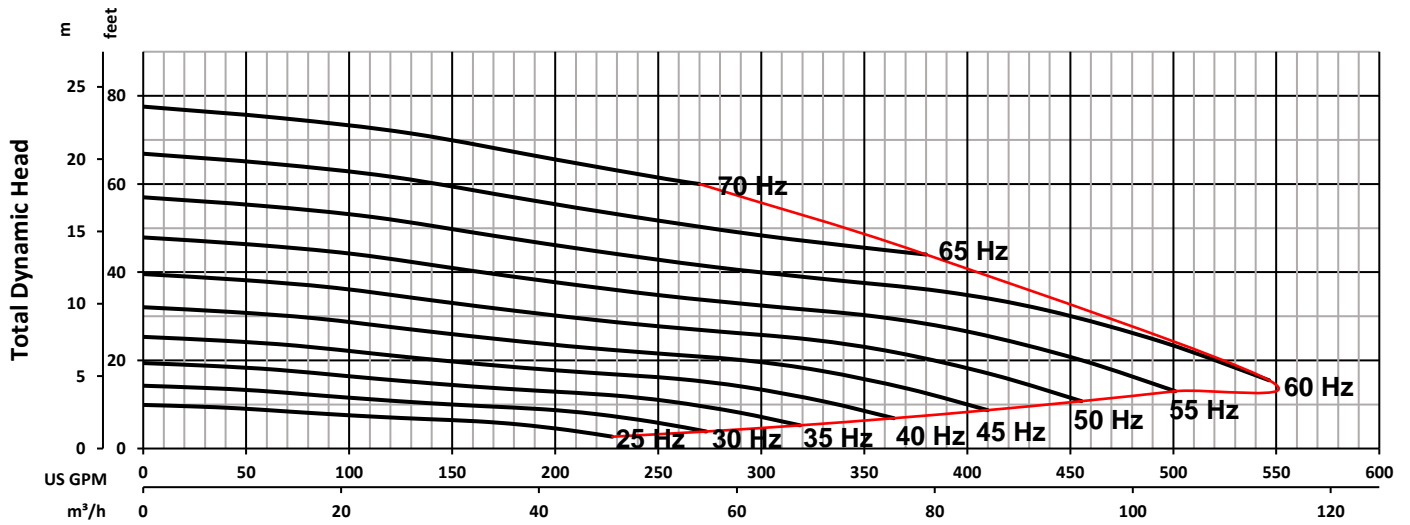

 INDUSTRIAL FLOW SOLUTIONS	PERFORMANCE CURVE OW31-4VV DC 7.5kW			DS-A50-192	
	Tested with clean water Test Standard : HI 11.6 Gr 3B		Model	OW31-4VV	
			Motor	7.5kW / 10.1HP	Poles 4
	Impeller	180x40mm		Rev 1	Date 3/14/2022
Specifications subject to change without notice					

PERFORMANCE CURVE OW31-4VV VX 2.2kW

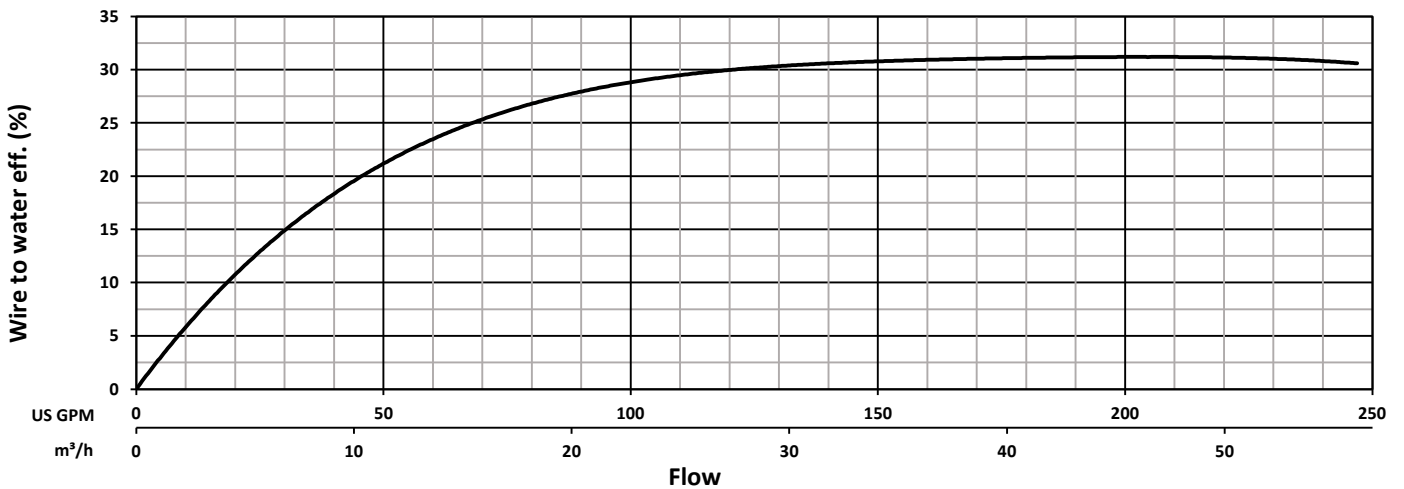
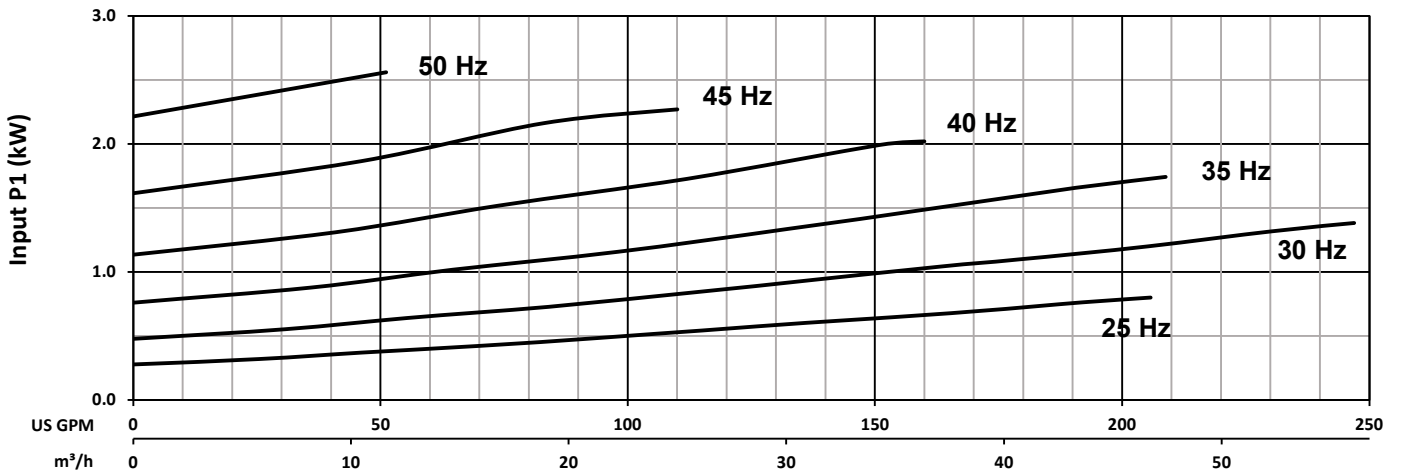
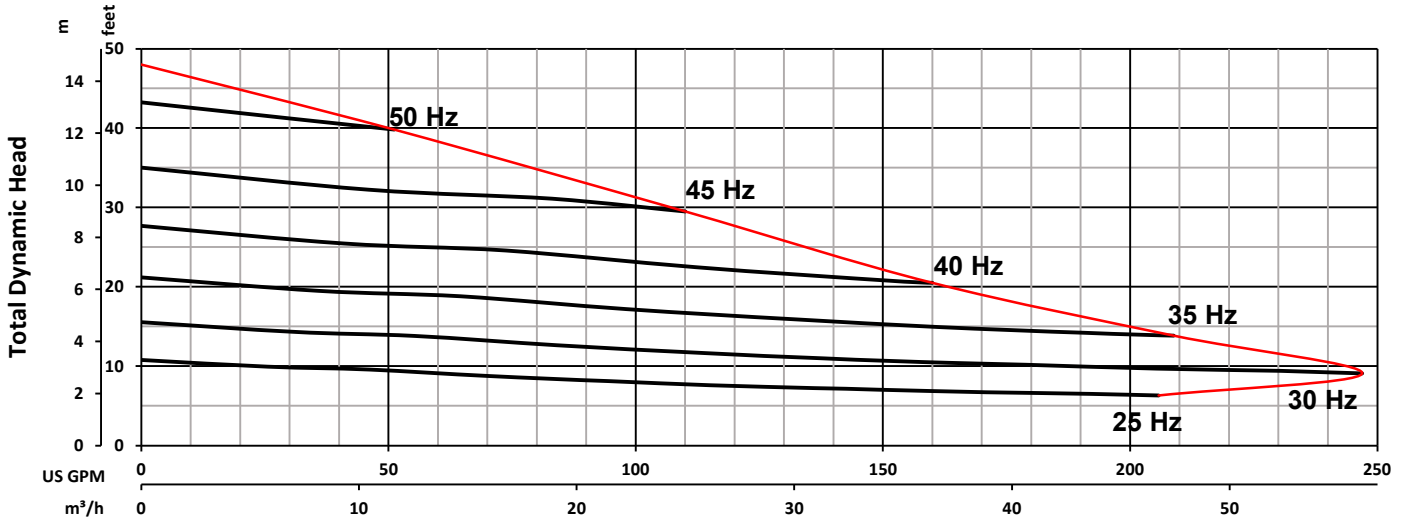

 INDUSTRIAL FLOW SOLUTIONS	PERFORMANCE CURVE OW31-4VV VX 2.2kW			DS-A50-182
	Tested with clean water Test Standard : HI 11.6 Gr 3B		Model	OW31-4VV
			Motor	2.2kW / 2.9HP
		Impeller Ø	185x40x20mm	Poles 4

PERFORMANCE CURVE OW31-4VV DC 5.5kW

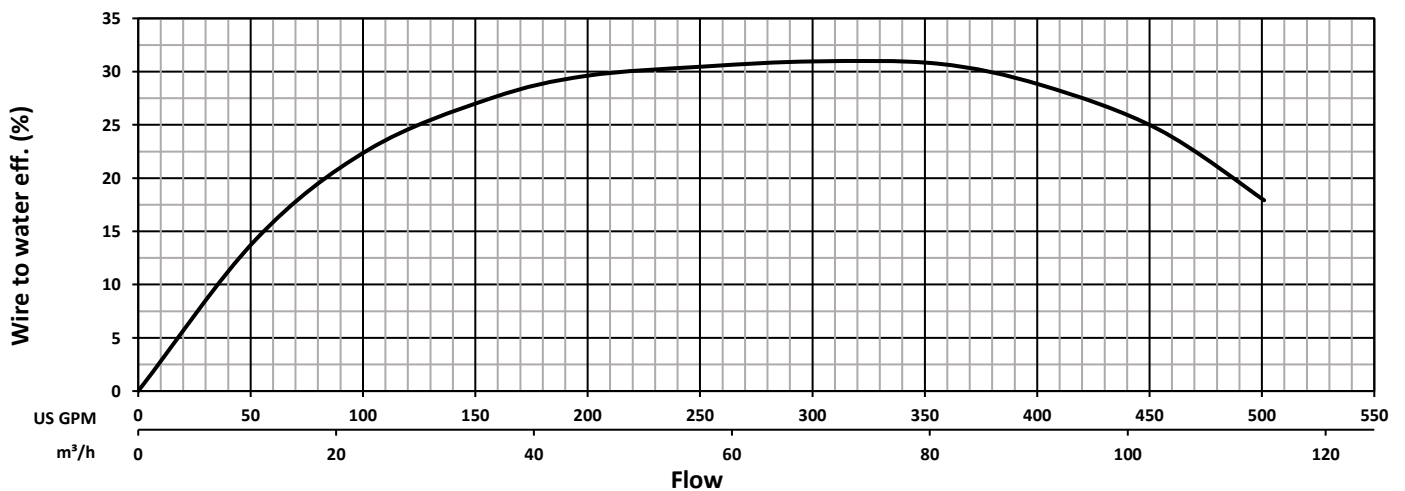
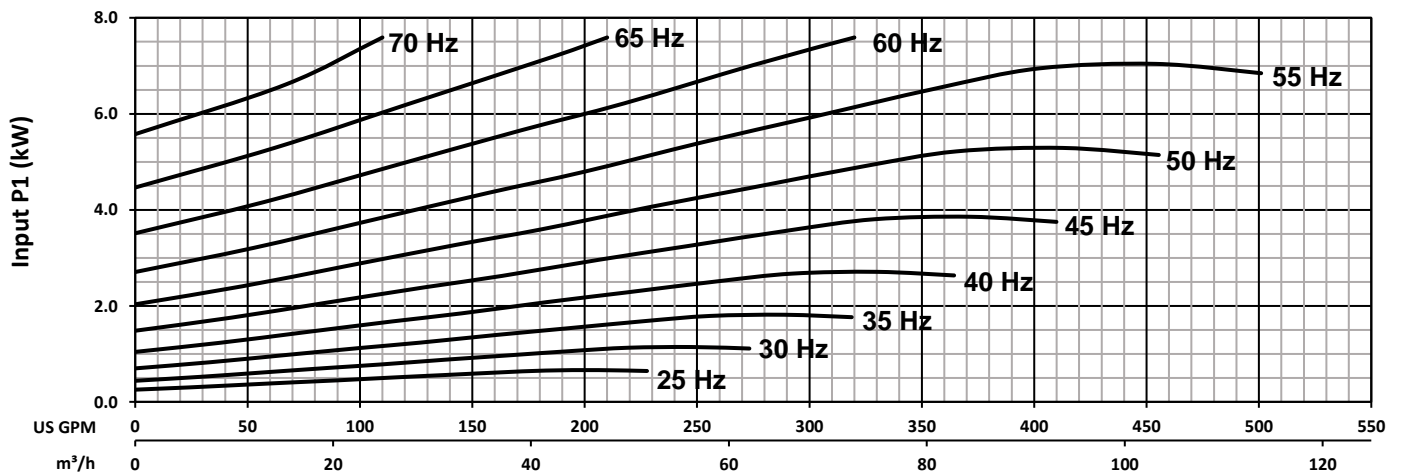
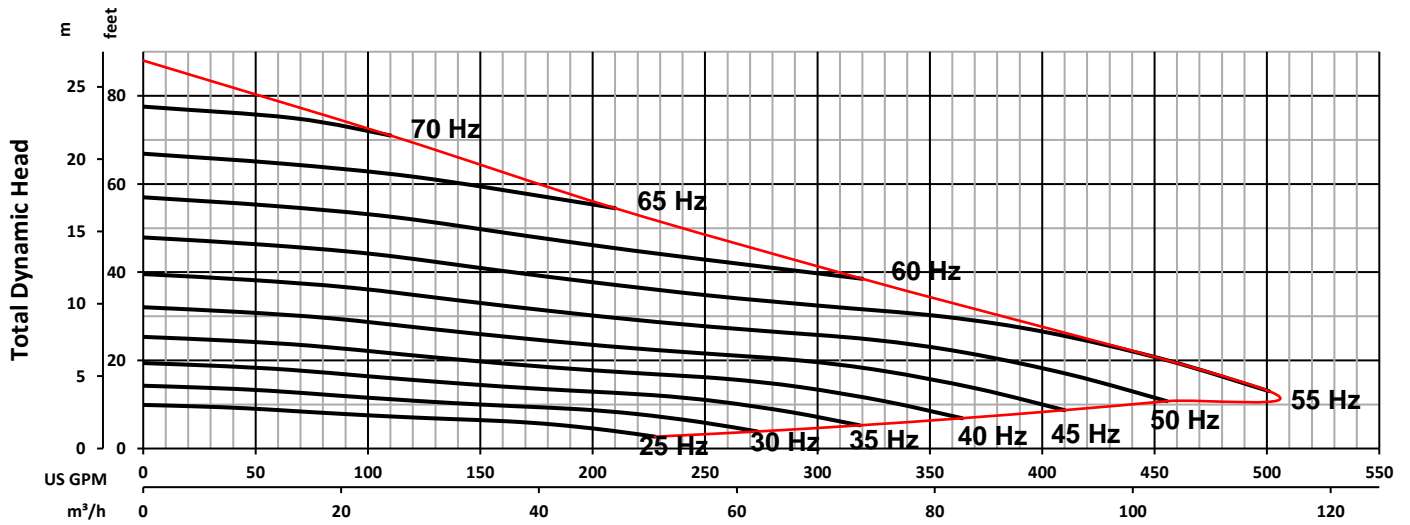

 INDUSTRIAL FLOW SOLUTIONS	PERFORMANCE CURVE OW31-4VV DC 5.5kW			DS-A50-181
	Tested with clean water Test Standard : HI 11.6 Gr 3B		Model	OW31-4VV
			Motor	5.5kW / 7.4HP
			Impeller	180x40mm
		Poles	4	Rev -- IT
				Date 3/24/2021
		Specifications subject to change without notice		

PERFORMANCE CURVE OW31-4VV VX 5.5kW

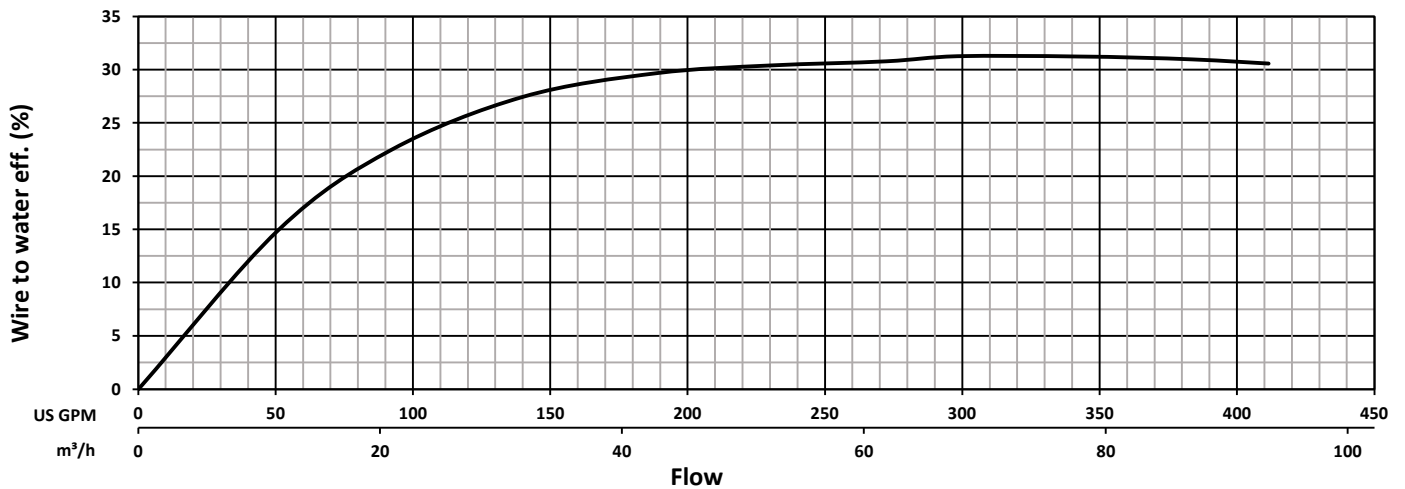
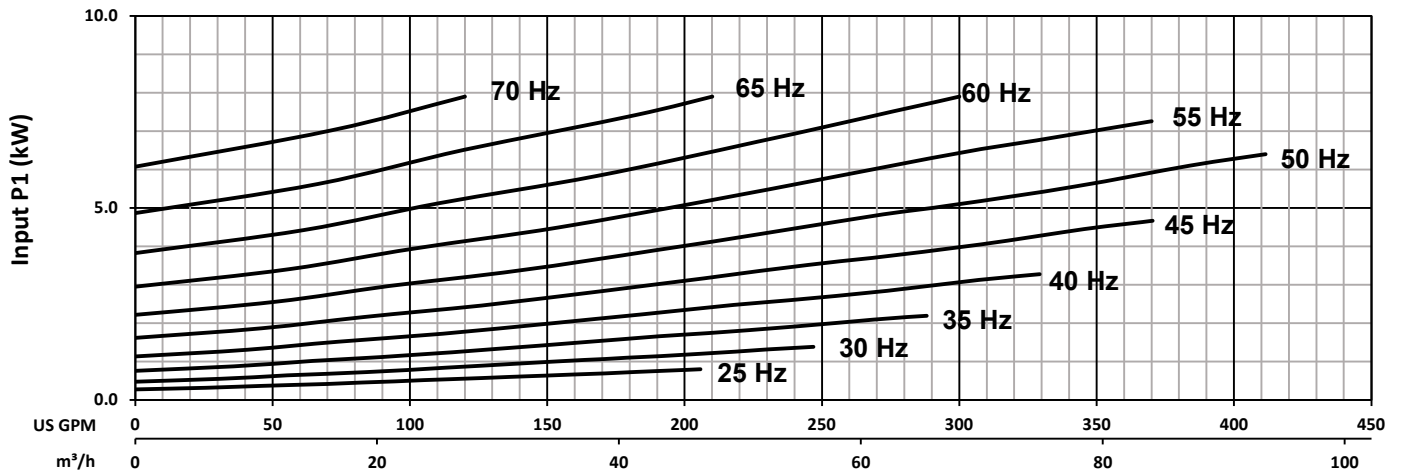
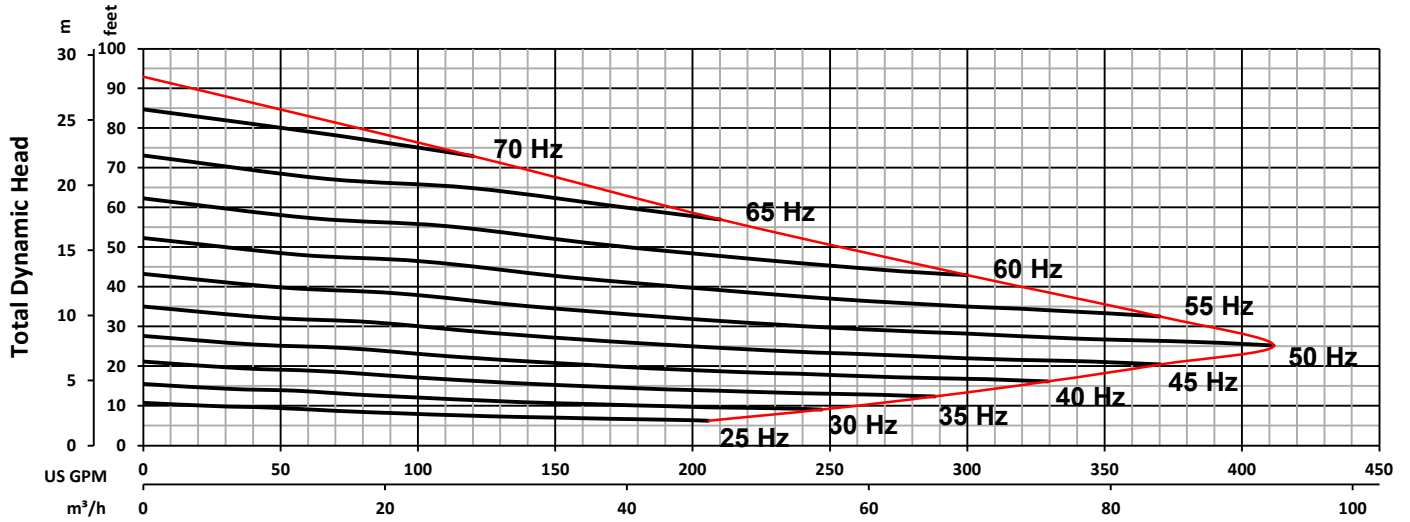

 INDUSTRIAL FLOW SOLUTIONS	PERFORMANCE CURVE OW31-4VV VX 5.5kW			DS-A50-013	
	Tested with clean water Test Standard : HI 11.6 Gr 3B		Model	OW31-4VV	
			Motor	5.5kW / 7.4HP	Poles 4
			Impeller Ø	185x40x20mm	Specifications subject to change without notice
		Rev 1	IT		Date 3/1/2021

PERFORMANCE CURVE OW31-4VV VX 4kW

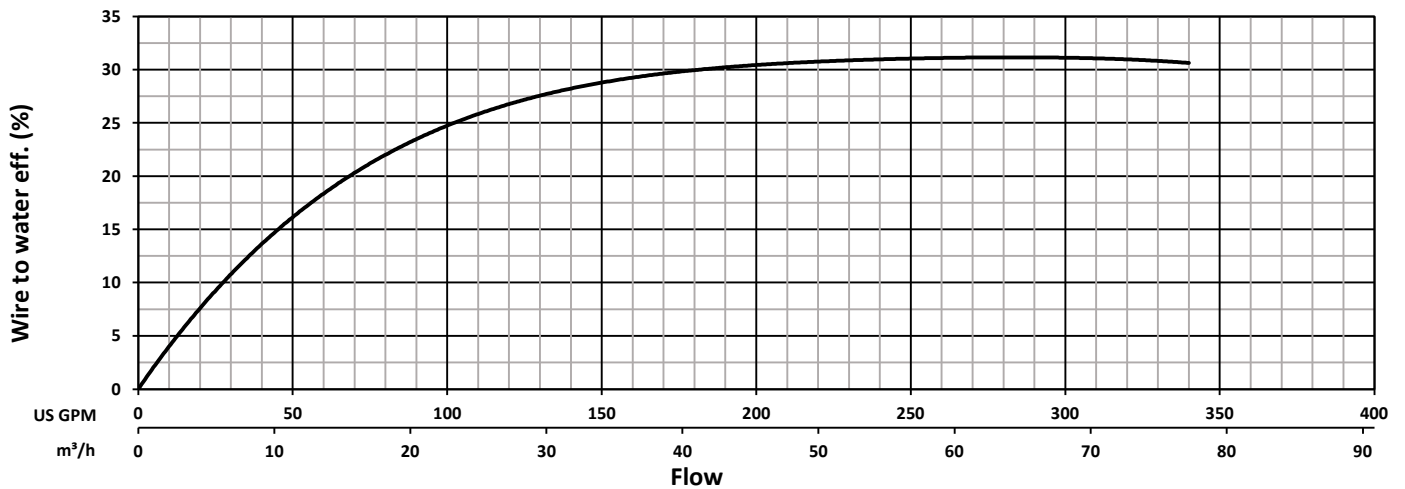
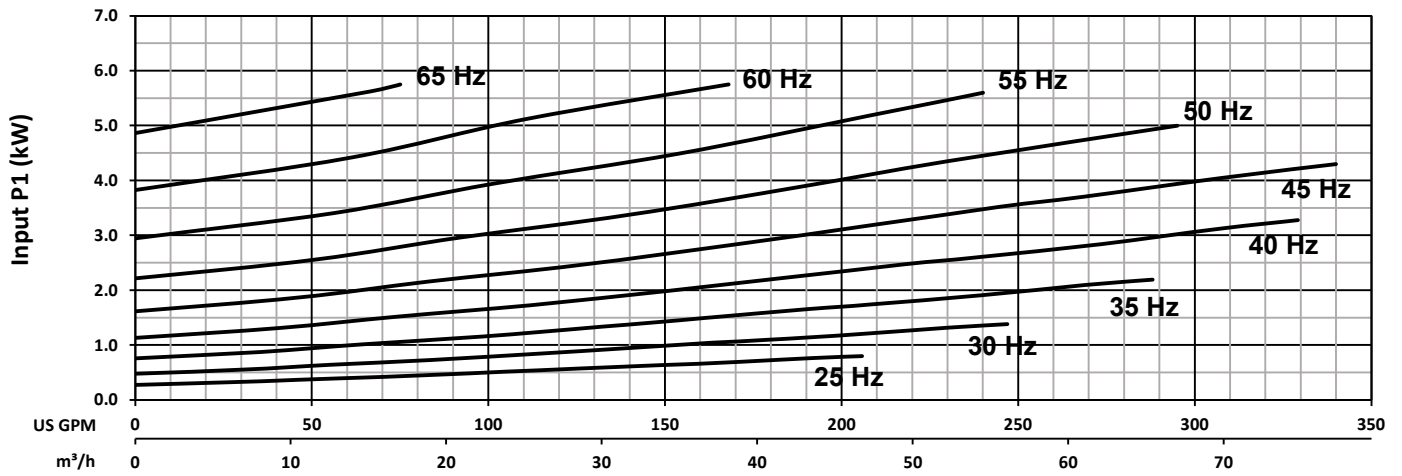
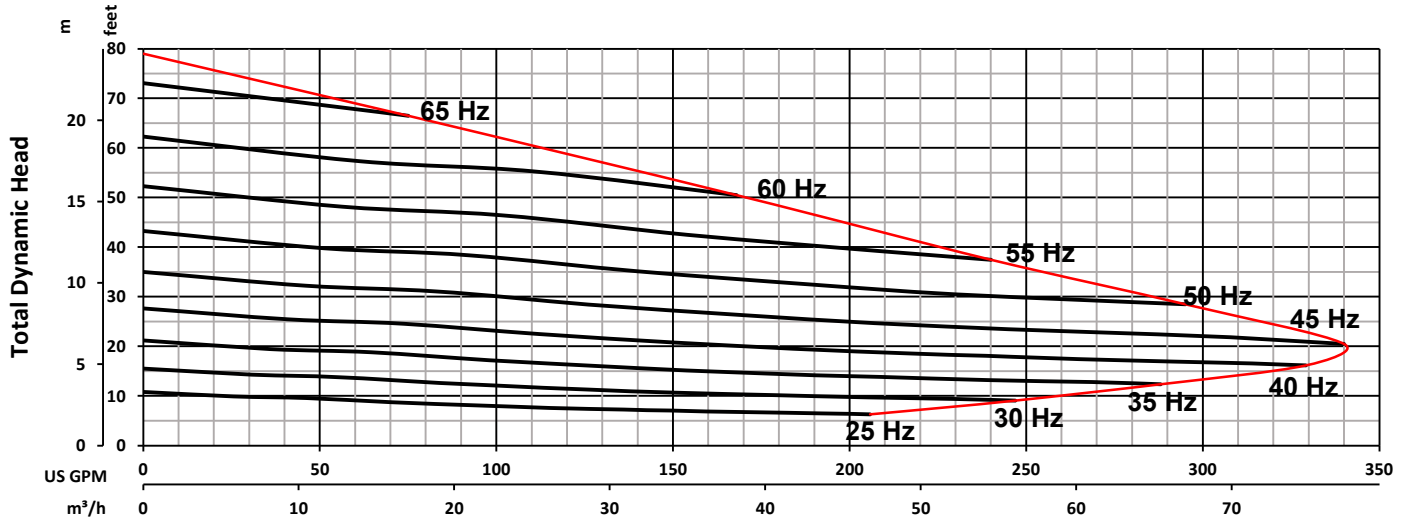

 INDUSTRIAL FLOW SOLUTIONS	PERFORMANCE CURVE OW31-4VV VX 4kW			DS-A50-031	
	Tested with clean water Test Standard : HI 11.6 Gr 3B		Model	OW31-4VV	
			Motor	4kW / 5.4HP	Poles
			Impeller Ø	185x40x20mm	Specifications subject to change without notice
				Rev	1 IT
				Date	3/1/2021

PERFORMANCE CURVE OW31-4VV VX 3kW

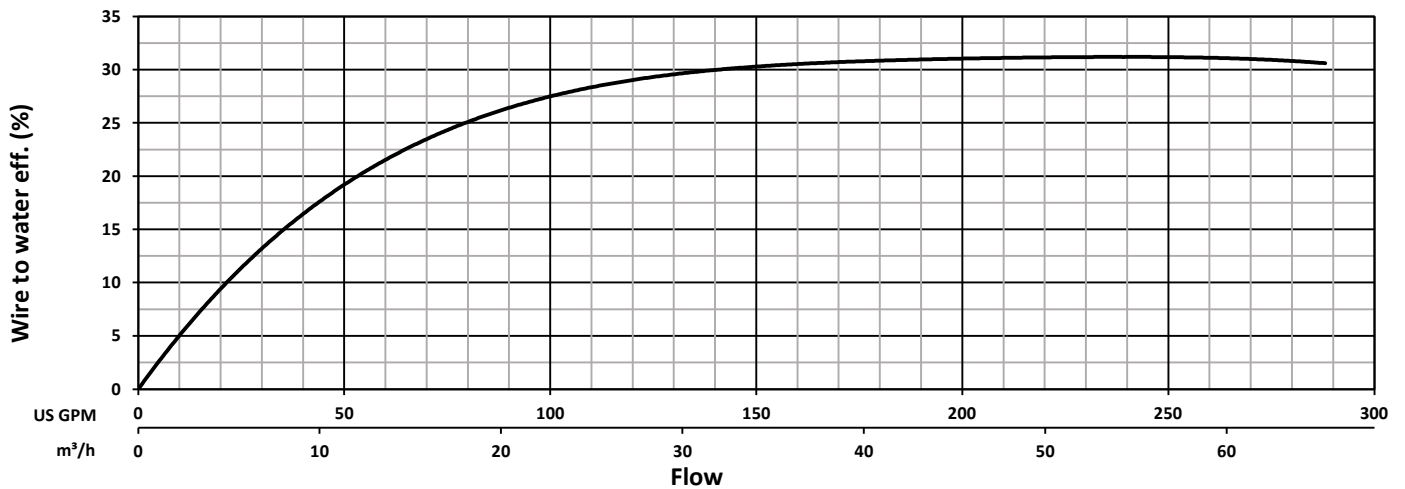
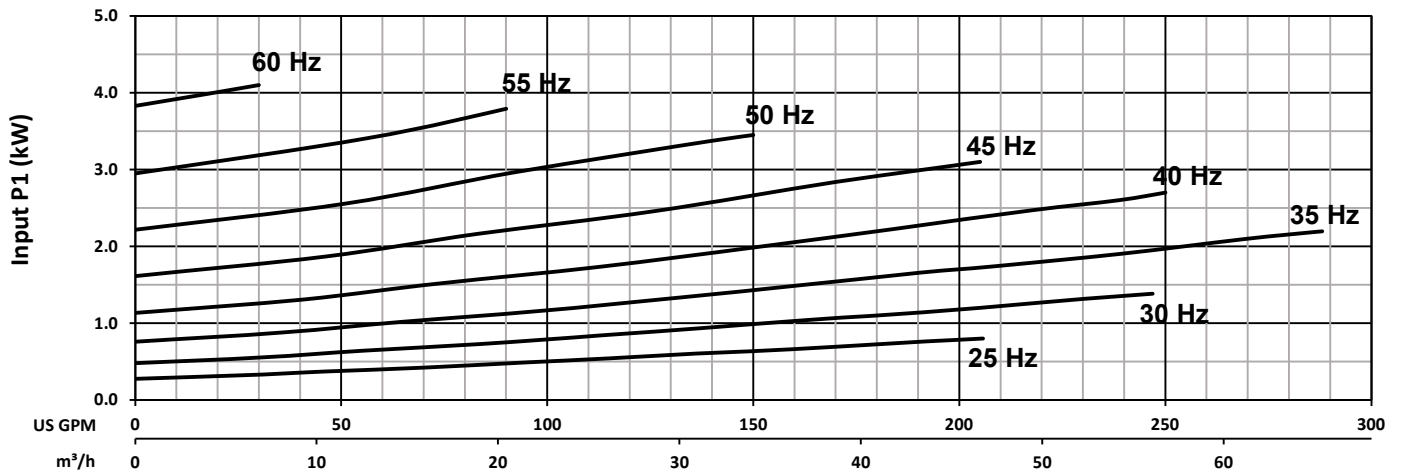
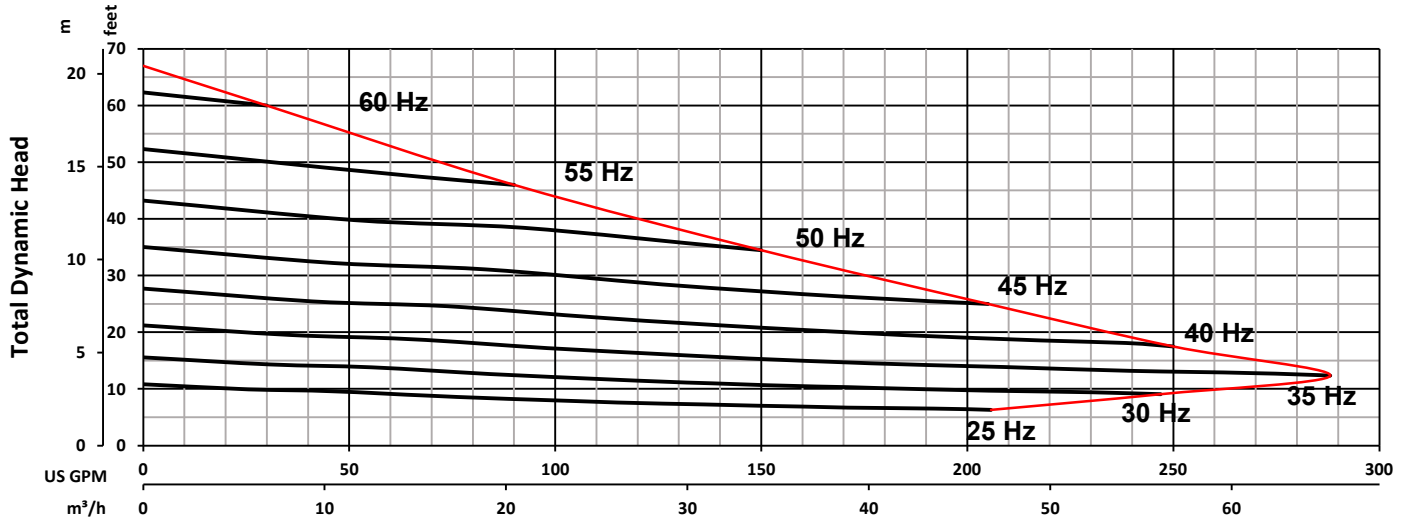

 INDUSTRIAL FLOW SOLUTIONS	PERFORMANCE CURVE OW31-4VV VX 3kW			DS-A50-011	
	Tested with clean water Test Standard : HI 11.6 Gr 3B		Model	OW31-4VV	
			Motor	3kW / 4HP	Poles 4
			Impeller Ø	185x40x20mm	Specifications subject to change without notice
			Rev 1	ITIC	
			Date 3/10/2021		